

The Subdivision Regulations come from the City of Laurel's Municipal Code that can be found online.

No changes have been made to the Regulations.

The Regulations contemplated the City exercising jurisdiction in the City and the County exercising jurisdiction outside of the City

Title 16

SUBDIVISIONS¹

Chapter 16.00 GENERAL PROVISIONS

Sections:

16.00.010 Title.

These regulations will be known and may be cited as "The Subdivision Regulations of the Laurel-Yellowstone City-County Planning Board and hereinafter referred to as "these regulations."

(Ord. No. O17-01, § 16.01, 3-7-2017)

16.00.020 Authority.

Authorization for these regulations is contained in the Montana Subdivision and Platting Act (MSPA) (Title 76, Chapter 3, Mont. Code. Ann.).

(Ord. No. O17-01, § 16.02, 3-7-2017)

16.00.030 Purpose.

The purposes of these regulations are to promote the public health, safety and general welfare of the citizens of Laurel and its planning jurisdictional area by regulating the subdivision of land and to promote a vision for the development for the best possible environment in which to enjoy life, experience natural features, raise a family, earn a living, conduct business, obtain an adequate education, have access to health care facilities, and to be adequately protected from crime and disasters. These regulations are intended to comply with Part 5 of MSPA and to provide for:

¹Editor's note(s)—Ord. No. O17-01, adopted March 7, 2017, amended and restated former Chapters 16.04—16.44 of Title 16 in their entirety. Former Chapters 16.04—16.44 pertained to similar subject matter and derived from the following: Ord. No. 07-01, 2007; Ord. No. 07-09, 2007; O08-02, 3-4-08; Ord. No. O13-01, 8-20-2013.

In order to conform to the numbering system of chapters and sections described on Page v of the preliminary pages of this code, the editor has renumbered the chapters and sections of Ord. No. O-17-01 accordingly. Original section numbers used in Ord. No. O17-01 can be found in the legislative history notes at the end of each section.

-
- A. The orderly development of the jurisdictional area in accordance with adopted growth policies, neighborhood plans, motorized and non-motorized transportation plans, park plans, and other adopted policies and plans.
 - B. The public health, safety, and general welfare of existing and future residents by avoiding danger or injury by reason of natural or manmade hazards.
 - C. The coordination of roads within subdivided land with the existing and planned transportation network and to avoid or minimize traffic congestion.
 - D. The dedication of adequate land for roadways, public utility easements, and pedestrian/bicycle pathways.
 - E. Proper physical and legal road access, including obtaining of necessary easements and rights-of-way.
 - F. The promotion of adequate open spaces for travel, light, air, and recreation.
 - G. Adequate, water, drainage, and sanitary facilities.
 - H. The consideration of impacts on natural resources and of development in harmony with the natural environment.
 - I. The promotion of cluster development that minimizes costs to local citizens that promotes effective and efficient provision of public services.
 - J. The efficient expenditure of public funds for public services.
 - K. The standardization of the land subdivision process.
 - L. The protection of the rights of all documented property owners affected by proposed subdivisions including water.
 - M. The administration of these regulations by defining the powers and duties of reviewing and approving authorities.

(Ord. No. O17-01, § 16.03, 3-7-2017)

16.00.040 Jurisdiction.

These regulations govern the subdivision of land within the jurisdictional area of the Laurel-Yellowstone City-County Planning Board as shown on the map filed with the Yellowstone County Clerk and Recorder's Office. The area is described as the lands lying within the city of Laurel and those lands extending four and one-half miles beyond the city limits. For purposes of these regulations, a map can be found in Appendix A.

These regulations supplement all other regulations, and where they are at variance with other laws, regulations, ordinances, or resolutions, the more restrictive requirements apply.

(Ord. No. O17-01, § 16.04, 3-7-2017)

16.00.050 Exemptions for certain divisions of land.

The Montana Subdivision and Platting Act provides that certain divisions of land, which would otherwise constitute subdivisions, are exempt from local subdivision review and approval, unless the method of disposition is adopted for the purpose of evading the requirements of Title 76, Chapter 3, Mont. Code Ann.

The procedures, criteria, and requirements provided in Appendix B shall be used to review an exemption from subdivision review and to evaluate whether the division of land is for the purpose of evading the Montana Subdivision and Platting Act.

(Ord. No. O17-01, § 16.05, 3-7-2017)

16.00.060 Interlocal coordination.

For subdivisions located within the city of Laurel or proposed for annexation, the Laurel City Council shall act as the AGB. For subdivisions located outside of the city of Laurel the Yellowstone Board of County Commissioners shall act as the AGB.

(Ord. No. O17-01, § 16.06, 3-7-2017)

16.00.070 Construction timing.

The applicant or his/her contractors may not proceed with any construction work on a proposed subdivision, including grading and excavation relating to public improvements, until the governing body has given preliminary plat approval of the proposed subdivision plat. If improvements are initiated prior to final plat approval, the subdivider shall assume all risks and liability for error in improvement placement, and the improvements must comply with the conditions and agreements of the preliminary plat approval.

(Ord. No. O17-01, § 16.07, 3-7-2017)

16.00.080 Transfers of title.

Except as noted below, a final subdivision plat must be filed for record with the Yellowstone County Clerk and Recorder before title to the subdivided land can be sold or transferred in any manner. After the preliminary plat of a subdivision has been approved or conditionally approved, the subdivider may enter into contracts to sell lots in the proposed subdivision if all of the following conditions are met (MCA § 76-3-303):

- A. That under the terms of the contracts the purchasers of lots in the proposed subdivision makes all payments to an escrow agent, which must be a bank, savings and loan association, or title/escrow company chartered to do business in the State of Montana;
- B. That under the terms of the contracts and the escrow agreement the payments made by purchasers of lots in the proposed subdivision may not be distributed by the escrow agent to the subdivider until the final plat of the subdivision is filed with the county clerk and recorder;
- C. That the contracts and the escrow agreement provide that if the final plat of the proposed subdivision is not filed with the county clerk and recorder within two years of the preliminary plat approval, the escrow agent shall immediately refund to each purchaser any payments made under the contract; and
- D. That the contracts contain the following language conspicuously set out therein: "The real property which is the subject hereof has not been finally platted, and until a final plat identifying the property has been filed with the county clerk and recorder, title to the property cannot be transferred in any manner."

(Ord. No. O17-01, § 16.08, 3-7-2017)

16.00.090 Suitability of land.

If the planning board finds any portion of a parcel of land proposed to be subdivided unsuitable for subdivision because of potential hazards such as flooding, land-slides, steep slopes, rock falls, high water table, polluted or non-potable water supply, high voltage lines, high pressure gas lines, danger from fire or explosion, or other features which may be detrimental to the health, safety, or general welfare of existing or future residents,

(Supp. No. 20)

Created: 2023-10-23 14:37:24 [EST]

they will not recommend approval of the subdivision unless the hazards can be eliminated or overcome through approved design and construction plans.

(Ord. No. O17-01, § 16.09, 3-7-2017)

16.00.100 Permission to enter.

The appropriate governing body (AGB) or its designated agent(s) or agency may investigate, examine, and evaluate the site of the proposed subdivision to verify information provided by the subdivider. The submission of a preliminary plat or final plat application constitutes a grant of permission by the subdivider to enter the subject property.

(Ord. No. O17-01, § , 3-7-2017)

16.00.110. Severability.

If a court of competent jurisdiction holds any word, phrase, clause, sentence, paragraph, section, or other part of these Regulations invalid, that judgment will affect only the part held invalid.

(Ord. No. O17-01, § 16.011, 3-7-2017)

16.00.120. Regulations in effect.

Review and approval or disapproval of a subdivision under these regulations may occur only under those regulations in effect at the time an application for approval of a preliminary plat or an extension of preliminary plat approval is submitted to the AGB.

(Ord. No. O17-01, § 16.012, 3-7-2017)

Chapter 16.02 DEFINITIONS

Sections:

16.02.010 Definitions.

Whenever the following words or phrases appear in these regulations, they shall have the meaning assigned to them by this section. The word "shall" is always mandatory, and the word "may" indicates use of discretion in making decisions.

"Access, legal": When the subdivision abuts a public street or road under the jurisdiction of the city, the county, or the state or when the subdivider has obtained adequate and appropriate written easements from a public road to the subdivision across all intervening properties.

"Access, physical": When a road or driveway conforming to city and/or county standards provides vehicular access from a public or private road to the subdivision in a manner to safely convey motorized vehicles, include emergency vehicles along the access.

"Adjoining property owners": Persons who are owners of record of properties adjoining the land being proposed for subdivision platting.

"AGB": "Appropriate governing body": Refers to either the City Council of Laurel or the Board of County Commissioners of Yellowstone County. Each governing body shall make decisions in their jurisdictions. Subdivision

located in Yellowstone County shall be reviewed by the County Commissioners of Yellowstone County and subdivisions located in the city of Laurel shall be reviewed by the Laurel City Council.

"Agriculture": Montana Code Annotated contains definitions for the words "agriculture" and "agricultural" as follows:

41-2-103, MCA. Definitions. As used in this part, the following definitions apply: (1) "Agriculture" means: (a) all aspects of farming, including the cultivation and tillage of the soil; (b)(i) dairying; and (ii) the production, cultivation, growing, and harvesting of any agricultural or horticultural commodities, including commodities defined as agricultural commodities in the federal Agricultural Marketing Act [12 U.S.C. 1141j(g)]; (c) the raising of livestock, bees, fur-bearing animals, or poultry; and (d) any practices, including forestry or lumbering operations, performed by a farmer or on a farm as an incident to or in conjunction with farming operations, including preparation for market or delivery to storage, to market, or to carriers for transportation to market.

81-8-701, MCA. Definitions. The following definitions apply: (1) "Agricultural and food product" includes a horticultural, viticultural, dairy, livestock, poultry, bee, other farm or garden product, fish or fishery product, and other foods.

"Agricultural water user facilities": Those facilities which convey water for agricultural land as defined in MCA § 15-7-202, or which provide water for the production of agricultural products as defined in MCA § 15-1-101, including, but not limited to, ditches, drains, pipes, and head gates.

"Agricultural water user": Persons and lands legally entitled to water under an appropriated water right or permit of an irrigation district or other private or public entity formed to provide for the use of the water right on subdivision lots.

"Applicant": The owner of land proposed for subdivision or the owner's legally designated representative for the purposes of submitting a request to subdivide (See "subdivider").

"Bikeway": A generic term for any road, street, path or way, which is specifically designated for bicycle travel, regardless of whether such facilities are designated for the exclusive use of bicycles or are to be shared with other transportation modes.

"Block": A group of lots, tracts, or parcels within well-defined and fixed boundaries. Such boundaries may include streets, railroads, irrigation ditches, streams, platted lands, or a combination thereof.

"Board of county commissioners": The governing body for Yellowstone County, Montana.

"Boulevard": An area of public right-of-way or private easement between the traveled edge of the street or road and the private property line. The boulevard provides for the opportunity to separate vehicle traffic from pedestrian travel. Boulevards often have sidewalks and mailboxes located in them and often are landscaped. A parkway median is a landscaped area located in the middle of the street or road.

"Buildings for lease or rent": Developments that are not subdivisions as defined by the Montana Subdivision and Platting Act. Buildings for lease or rent are governed by the ordinances found in Chapter 18 of the Laurel Municipal Code.

"Certificate of survey": A drawing of a field survey prepared by a registered surveyor for the purpose of disclosing facts pertaining to boundary locations.

"Conservation subdivision": A development in a rural setting that is characterized by compact lots and common open space, and where the natural features of land are maintained to the greatest extent possible.

"Checkprint": A paper copy of the final plat submitted by the subdivider to the planner for review for compliance with the Administrative Rules of Montana and conditions of approval set by the AGB by staff prior to submitting the final plat on Mylar.

"City council": The governing body for the city of Laurel, Montana.

"Cluster development": A subdivision of land with lots clustered in a group of five or more lots that is designed to concentrate building sites on smaller lots in order to reduce capital and maintenance costs for infrastructure through the use of concentrated public services and utilities, while allowing other lands to remain undeveloped (MCA § 76-3-103(2)).

"Condominium": A form of individual ownership with unrestricted right of disposal of one or more units in a multiple unit project with the land and all other parts of the project held in common ownership or use by owners of the units (MCA § 70-23-101, et. seq.).

"Covenant (deed restriction)": A limitation contained in a deed that restricts or regulates the use of the real property.

"Dedication": The deliberate appropriation of land by an owner for any general and public use, reserving to the landowner no rights that are incompatible with the full exercise and enjoyment of the public use to which the property has been devoted (MCA § 76-3-103(3)).

"DEQ": Montana Department of Environmental Quality.

"Division of land": The segregation of one or more parcels of land from a larger tract held in single or undivided ownership by transferring or contracting to transfer title to or possession of a portion of the tract or properly filing a certificate of survey or subdivision plat establishing the identity of the segregated parcels pursuant to the Montana Subdivision and Platting Act. The conveyance of a tract of record or an entire parcel of land that was created by a previous division of land is not a division of land (MCA § 76-3-103(4)).

"Driveway": A vehicular access serving no more than two lots or five dwelling units.

"Dwelling unit": Any building or portion thereof providing complete, independent, and permanent living facilities for one family. A family is any number of individuals, related by blood, marriage, adoption, or other legal means, including any number of minor children in foster care, and/or any number of unrelated persons (including any domestic servants or caregivers) living together in a dwelling unit (24 CFR Part 4, Section 982.401).

"Easement": Authorization by a property owner for another to use the property for a specified purpose, in which the owner agrees not to build, obstruct, or interfere with the specified purpose.

"Engineer (registered professional engineer)": A person licensed in conformance with the Montana Professional Engineers' Registration Act (MCA § 37-67-301 et. seq.) to practice engineering in Montana.

"Flood": When water from any watercourse or drainage rises above the bank or moves outside the channel of that watercourse or drainage (MCA § 76-5-103(8)).

"100-year flood": A flood magnitude expected to recur on the average of once every one hundred years, or a flood magnitude, which has a one-percent chance of occurring in any given year (MCA § 76-5- 103(9)).

"Floodplain": The area adjoining the watercourse or drainway that would be covered by the floodwater of a flood of one hundred-year frequency, except for sheetflood areas that receive less than one foot of water per occurrence are considered "zone B" or a "shaded X zone" (MCA § 76-5-103(10)).

"Floodway": The channel of a watercourse or drainage and those portions of the floodplain adjoining the channel that are reasonably required to carry and discharge the floodwater of any watercourse or drainage, no construction is permitted in the floodway unless permitted by the city of Laurel or Yellowstone County Floodplain Administrator. (MCA § 76-5-103(11)).

"Greenbelt/greenway": Corridors of protected open space managed for conservation and recreation purposes as designated by the AGB. Such corridors may be privately or publicly owned.

"Growth management plan/growth policy": The plan adopted by the city of Laurel to guide growth and change in the Laurel Planning Jurisdictional Area (MCA § 76-1-601).

"Lot": A parcel, plot, tract, parcel or other land area created by subdivision, plat or certificate of survey for sale, rent, or lease.

"Lot measurements":

- a. Lot Depth: The length of a line drawn perpendicularly to the front lot line and extending to the rear lot line.
- b. Lot Width: The average width of the lot.
- c. Lot Frontage: The width of the lot line that fronts a public street right-of-way or public road easement where the lot usually has a driveway access.
- d. Lot Area: The area of a lot determined exclusive of street, highway, alley, road, or other rights-of-way.

"Lot types":

- a. Corner Lot: A lot located at the intersection of two streets.
- b. Interior Lot: A lot with frontage on only one street.
- c. Through or Double-Frontage Lot: A lot whose front and rear lines both abut on streets.
- d. Flag Lot.
- e. Irregular Lot.

Figure 2.1 Lot Types

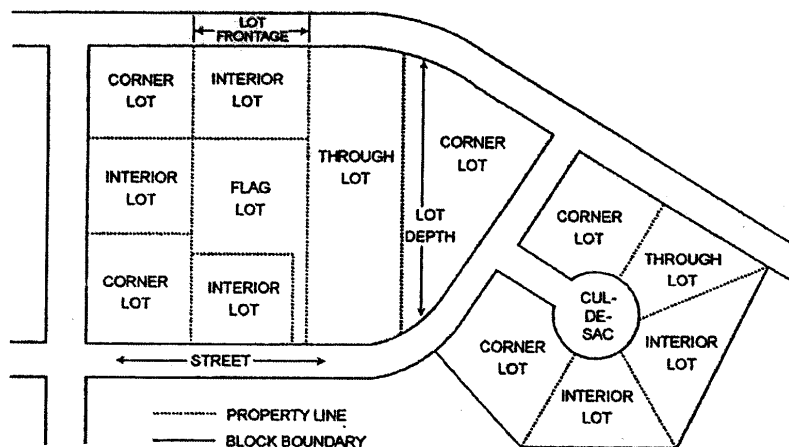

"Manufactured home": A detached residential dwelling unit, which may consist of two or more sections, fabricated at a factory and designed to be towed on its own chassis to a building site for occupation as a dwelling with or without a permanent foundation. The term includes, but is not limited to, "trailer homes," "house trailers," and "mobile homes" whether or not the unit has been constructed after July 1, 1976, in conformance with Federal Manufactured Home Construction and Safety Standards. The term does not include "modular" or "factory-built buildings" that are fabricated at a factory in accordance with the International Residential/Building Code applicable to site-built homes, and are transported to the site for final assembly on a permanent foundation. See also Laurel Zoning Code 17.08.763.

"Manufactured home space": A designated portion of a parcel of land designed for the accommodation of one manufactured home and its accessory buildings or structures for the exclusive use of the occupants.

"Manufactured home park": A single parcel of land or a lot that is designed or used for temporary or permanent spaces for two or more manufactured homes where either the space for a manufactured home or a manufactured home itself is available to the general public for residential use.

"Manufactured home pad": That area of a manufactured home space that has been prepared for the placement of a manufactured home.

"Master plan" (overall plan; sequential development): The plan of a subdivision designed for a single tract and proposed to be subdivided in various stages, phases or configurations.

"Median": A raised divider made of dirt, concrete, or other material located in the middle of a street or road between travel lanes that is often landscaped.

"Mobile home" or "trailer": See "manufactured home." See also Laurel Zoning Code 17.08.763.

"Modular home": A dwelling unit constructed in accordance with the standards set forth in the International Residential/Building Code and bearing the insignia of the State of Montana, applicable to site-built homes, and composed of components assembled in a manufacturing plant and transported to the building site for final assembly on a permanent foundation.

"Monument (permanent monument)": Any structure of masonry, metal, or other permanent, durable material placed in the ground, which is exclusively identifiable as a monument to a survey point, expressly placed for surveying reference.

"No access easement": A line designated on a subdivision plat for the purpose of restricting vehicular access from a public right-of-way to a lot.

"Planning board": The Laurel-Yellowstone City-County Planning Board.

"Planning director": The Laurel Planner.

"Plat": A graphical representation of a subdivision showing the division of land into lots, parcels, blocks, streets, alleys, and other divisions and dedications.

- a. Preliminary Plat: A neat and scaled drawing of a proposed subdivision showing the layout of streets, alleys, lots, blocks, and other elements of a subdivision that furnishes a basis for review by a governing body.
- b. Final Plat: The final drawing of the subdivision and dedication required to be prepared for filing for record with the county clerk and recorder containing all elements and requirements set forth in these regulations and the Montana Subdivision and Platting Act (MCA §76-3-101 et. seq.) (MSPA).
- c. Amended Plat: The final drawing of any change to a filed platted subdivision.
- d. Exempt Plat: A survey or plat that is exempt from local subdivision review and approval under the provisions of the MSPA and as described in Appendix B of these regulations.

"Professional Engineer": See "engineer."

"Public road or street": A road or street that has been dedicated and accepted for public use, or an easement that has been granted and accepted for public use or has been created by judicial fiat or any other operation of law.

"Recreational camping vehicle": A vehicle primarily designed as temporary living quarters for recreational, camping, or travel use that either has its own motor power or is mounted on or drawn by another vehicle.

"Recreational vehicle park": Any area or tract of land designed or used that contains two or more spaces which are available for rent to the general public for parking or placement of temporary recreational vehicles. This term does not include a parcel composed of individually platted lots.

"Sidewalk": A minimum five-foot wide concrete walkway for non-motorized traffic only built to city or county standards and provided within the road right-of-way, an easement, or within parkland as applicable.

"Street types": For purposes of these regulations, street types are defined using the Institute of Transportation Engineers Manual as follows:

- a. Alley: Minor rights-of-way used primarily for vehicular access to the back or side of properties that abut on and are otherwise served by public roads.
- b. Arterial: Any major carrier of traffic which generally terminates at both ends at a location that will produce more than two thousand vehicles per day traffic, or upon which the nature of the traffic is such that more than sixty percent of the vehicles are using the street for mobility rather than land access. Typically they are located no more than one mile apart.
 1. Principal Arterial: A street which serves the major centers of a metropolitan area, the highest traffic volume corridors, and the longest trip desires, and which carries a high proportion of the total urban area travel on a minimum of mileage.
 2. Minor Arterial: A street that interconnects with and augments the principal arterials, provides service to trips of moderate length at a lower level of travel mobility than principal arterials, and distributes travel to geographic areas smaller than those identified as principal arterials.
- c. Collector: A street that generally terminates at both ends at an arterial or collector but because of location, curvilinear design, or limited feeder area will not generally serve more than two thousand vehicles per day, or the nature of the traffic is such that approximately fifty percent of the traffic is using the street for land access and fifty percent for mobility. Typically they are located between arterial streets at no more than one-half mile from an arterial street.
- d. Cul-de-sac: A street having only one outlet for vehicular traffic and terminating in a turn-around area.
- e. Frontage Access (Service Road): A local or collector street, usually parallel and adjacent to an arterial or major collector, which provides access to abutting properties and controls traffic access to arterials or collectors.
- f. Half-Street: A portion of the width of a street, usually located along the perimeter of a subdivision, the remaining portion of which street must be located on adjacent property if the street is to be fully constructed.
- g. Local Streets: A street or road having the primary function of serving abutting properties, and the secondary function of moving traffic.
- h. Loop: A local street which begins and ends on the same street, generally used for access to properties.
- i. Urban Route: Roadways which have been identified by the Montana Department of Transportation that must be constructed to urban standards.

"Subdivision": A division of land or land so divided which creates one or more parcels containing less than one hundred sixty acres that cannot be described as a one-quarter aliquot part of a United States government section, exclusive of public roadways, in order that the title to or possession of the parcels may be sold, rented, leased, or otherwise conveyed and includes any re-subdivision and further includes a condominium or area, regardless of its size, that provides or will provide multiple space for recreational camping vehicles or mobile homes (MCA § 76-3-103(15)). However, condominiums constructed on land divided in compliance with the Montana Subdivision and Platting Act are exempt from the provisions of the Act (MCA § 76-3-203).

"Subdivision, major": A subdivision that does not qualify for review as a minor subdivision.

"Subdivision, first minor": A subdivision of a parcel that has never been subdivided or created by a subdivision, or has not resulted from a tract of record that has had more than five parcels created from that tract

of record under MCA § 76-3-201 or MCA § 76-3-207 since July 1, 1973 (MCA §76-3-609(2)). Furthermore the first minor subdivision contains five or fewer lots, and legal and physical access to all lots are provided and no land is required to be dedicated to public use for parks or playgrounds.

"Subdivision, subsequent minor": Divisions of land creating five or fewer lots that are not first minor subdivisions from a tract of record. Subsequent minor subdivisions located within the Laurel city limits are reviewed as minor subdivisions.

"Development for rent or lease": A development for rent or lease is created when any portion of a parcel is rented or leased for the purposes of temporary or permanent residential or commercial use. The rented/leased land is owned as one parcel under single ownership, which can include a number of persons owning the property in common. Subdivisions created by rent or lease are exempt from the survey and filing requirements of the Montana Subdivision and Platting Act (MSPA), but must be submitted for review and approval by the governing body before portions thereof may be rented or leased.

"Surveyor (registered land surveyor)": A person licensed in conformance with the Montana Professional Engineer's Registration Act (Title 37, Chapter 67, Mont. Code Ann.) to practice surveying in the State of Montana.

"Townhome/townhouse": Property that is owned subject to an arrangement under which persons own their own units and hold separate title to the land beneath their units, but under which they may jointly own the common areas and facilities.

"Tract of record": An individual parcel of land, irrespective of ownership, that can be identified by legal description, independent of any other parcel of land, using documents on file in the records of the county clerk and recorder's office (MCA § 76-3-103(17)(a)).

"Vicinity sketch": A map included with a site plan or placed on a plat that enables the viewer to clearly determine the location of a proposed subdivision in the city or county.

"Zoning jurisdiction": The area identified as one mile beyond the City of Laurel city limits which has adopted zoning administered by the city of Laurel.

(Ord. No. O17-01, ch. 16.2 3-7-2017)

Chapter 16.03 SUBDIVISION REVIEW PROCEDURES.

16.03.010 Compliance with local regulations and state law.

No subdivision of any lot, tract, or parcel of land shall be undertaken; no street, sanitary sewer, storm sewer, water main, or other facilities in connection therewith shall be constructed, opened, or extended for public use and travel, or for the common use of occupants of buildings except in strict accordance with these regulations and related state statutes.

(Ord. No. O17-01, § 16.3.1, 3-7-2017)

16.03.020 Preapplication meeting.

All owners of record, subdividers, and their authorized representative shall meet with the planner and other city or county departments prior to submitting the required preliminary plat application. The purpose of this meeting is to discuss these regulations and standards and to familiarize the subdivider with the applicable Laurel goals and objectives. The subdivider must provide a sketch plan of the proposed subdivision for review and discussion. The sketch plan must be legibly drawn showing the rough layout of proposed features in relation to existing conditions. The sketch plan may be made directly on a topographic map with scale no greater than 1"=400'

and sufficient to show all required information. Approximate tract and lot boundaries, location of easements, utilities, rights-of-way, parks and open spaces, roadways, and a description of general terrain, natural features, existing structures and improvements, and proposed public improvements must be included.

- A. A pre-application meeting checklist specifying the items required for subdivision application, review, and approval will be utilized to conduct the pre-application meeting and must be signed by the planner and the owners of record, subdividers, or their authorized representatives attending the pre-application meeting.
- B. In addition to the pre-application meeting checklist, applicants will also receive a preliminary plat submittal checklist and a list of utility and service providers.
- C. If during the review of the application the agent or agency designated by the governing body contacts a public utility, agency, or other entity that was not included on the list originally made available to the subdivider, the agent or agency shall notify the subdivider of the contact and the time frame for response.

(Ord. No. O17-01, § 16.3.2, 3-7-2017)

16.03.030 Major preliminary plat application submittal.

- A. Required. The subdivider shall submit to the planning director or designee for review and recommendation a preliminary plat of the proposed major subdivision, which conforms, to the requirements of these regulations. Information required in submittal of plats and supporting documents shall be performed by or under the supervision of a registered land surveyor or professional engineer licensed to practice in the State of Montana as their respective licensing laws allow.
- B. Application Submittal. Complete and sufficient applications for major preliminary plat approval shall be made to the planning office. When the date of submittal falls on a weekend or holiday, the submittal shall be on the following working day. The application form is provided in Appendix E "Preliminary Plat Application" and must be accompanied by the required preliminary plat, supporting documents, and applicable fee.
- C. Review of Subdivision Application for Required Elements and Sufficiency of Information:
 - 1. Within five working days of receipt of a subdivision application and review fee, the planner shall determine whether the application contains all required submission materials as required by Appendix F and shall notify the subdivider, or with the subdivider's written permission, the subdivider's agent, of the reviewing agent's or agency's determination. If the planner determines that elements are missing from the application, he/she shall identify those elements in the notification.
 - 2. Within fifteen working days after the planner notifies the subdivider or the subdivider's agent that the application contains all of the required elements, the planner shall determine whether the application and required elements contain detailed supporting information that is sufficient to allow for the review of the proposed subdivision under the provisions of this chapter and shall notify the subdivider or, with the subdivider's written permission, the subdivider's agent of the reviewing agent's or agency's determination.
 - 3. If the planner determines that information in the application is not sufficient to allow for review of the proposed subdivision, the planner shall identify the insufficient information in its notification. A determination that an application contains sufficient information for review does not ensure that the proposed subdivision will be approved or conditionally approved by the AGB and does not limit the ability of the planner or the AGB to request additional information during the review process. The time limits provided in the preceding paragraphs 1 and 2 herein apply to each submittal of the application until:

-
- a. A determination is made that the application contains the required elements and sufficient information; and
 - b. The subdivider or the subdivider's agent is notified.
4. After the planner has notified the subdivider or the subdivider's agent that an application contains sufficient information delineated herein, the AGB shall approve, conditionally approve, or deny the proposed subdivision within sixty working days based on its determination of whether the application conforms to the provisions of these regulations. For major subdivisions over fifty lots, the AGB shall approve, conditionally approve, or deny the proposed subdivisions with eighty working days. The subdivider and the planner may agree to an extension or suspension of the review period, not to exceed one year, or a subsequent public hearing is scheduled and held as provided in herein. (MCA; s; 76-3-604(4))
- D. Preliminary Plat Contents and Submittal Copies.
 1. Content. The preliminary plat shall clearly show on the face of the plat the information listed in Appendix D "Preliminary Plat Requirements."
 2. Copies. The subdivider shall provide the number of copies of the preliminary plat as determined by the planning director or designee at the time of the preapplication meeting. All plats shall be twenty-four-inch by thirty-six-inch size and/or eleven-inch by seventeen-inch size as specified by the planning director or designee. Electronic copies of the plat shall be provided as follows; one copy in .pdf, .jpg or .tif format and one copy in either .dwg or .dxf format is requested.
 - E. Supporting Documentation.
 1. Required Documents. The supporting information shall include those documents listed in Appendix F "Required Supporting Documents for Major Preliminary Plat Applications."
 2. Required Copies. The subdivider shall provide the number of copies of the supporting documents as determined by the planning director or designee at the preapplication meeting. All documents shall be typed and in a format specified by the planning director or designee.

(Ord. No. O17-01, § 16.3.3, 3-7-2017)

16.03.040 Staff and agency review.

- A. Review Procedure Schedule. Upon receipt of a complete and sufficient major preliminary plat application, the planning director or designee shall schedule the plat before the city-county planning board.
- B. Submittal Distribution. Planning staff shall distribute the application to all affected city and county departments, local, state, and federal agencies, school districts and public utilities for review as appropriate and indicate the review timeframe. Failure of any agency to complete a review of a plat will not be the basis for denial of the plat by the AGB.
- C. Plat Review. The planner shall review the major subdivision plat submittal and make a staff report of issues, concerns, conditions, or recommendations and send out the list to the planning board members with the agenda of the meeting at which the plat is to be reviewed; a copy must also be sent to the subdivider or his representative.
- D. Hearing Notice. The planning board shall hold a public hearing on all major and applicable subsequent minor preliminary plat applications, placing a notice in a newspaper of general circulation in Laurel not less than fifteen days prior to the date of a public hearing. The planner shall also notify the subdivider and each property owner of record, and each purchaser under contract for deed of record of property immediately

adjoining land included in the plat and located within three hundred feet of the proposed subdivision by certified mail not less than fifteen days prior to the date of hearing (MCA § 76-3-605(3)).

- E. Planner's Report. The planner shall prepare a draft findings of fact (the effect on agriculture, agricultural water user facilities, local services, the natural environment, wildlife and wildlife habitat, and public health and safety as per MCA § 76-3-608(3)(a)) for review by the planning board. The planner shall also forward the recommendation of the planning board to the AGB including basis for such recommendation and its compliance with adopted Growth Management Plan, the Bike/Ped Plan, and other adopted city and county plans and policies in writing no later than ten days after the public hearing (MCA § 76-3-605(4)).
- F. Subsequent Hearing. Before acting on the subdivision application, the AGB shall determine whether, subsequent to the public hearing, new information has become available or information that the public has not had a reasonable opportunity to examine. If so, the AGB may act on the subdivision application in accordance with this chapter or schedule a subsequent public hearing for consideration of only the new information that may have an impact on the findings and conclusions that the AGB will rely upon in making its decision on the proposed subdivision. The AGB may chose to hold the subsequent public hearing or may direct the planning board to hold it. In either case, the subsequent public hearing shall be held at the next scheduled meeting for which proper notice for the public hearing on the subdivision application can be provided.

If a subsequent hearing is held, the sixty- or eighty-day working day review period is suspended, and the new hearing must be noticed and held within forty-five days of the AGB's determination to hold a subsequent public hearing. The sixty- or eighty- working day review period will resume from the date of the subsequent public hearing. The governing body may not consider any information that is presented after the subsequent hearing (MCA § 76-3-615).

- G. Subdivider's Preference. The AGB shall give due weight and consideration to the subdivider's expressed preferences if the AGB requires mitigation of significant adverse impacts (MCA § 76-3-608(5)(b)).

(Ord. No. O17-01, § 16.3.4, 3-7-2017)

16.03.050 Governing body action.

A governing body may not deny approval of a subdivision based solely on the subdivision's impacts on educational services (MCA § 76-3-608(1)) or solely on failure to comply with the growth policy (MCA § 76-1-605(2)(b)).

In reviewing a subdivision and when requiring mitigation, the AGB may not unreasonably restrict a landowner's ability to develop land, but it is recognized that in some instances the unmitigated impacts of a proposed development may be unacceptable and will preclude approval of the plat (MCA §76-3-608(5)(a)).

The AGB shall send the subdivider written notice of its decision and the reason therefore. (MCA § 76-3-608(4)).

(Ord. No. O17-01, § 16.3.5, 3-7-2017)

16.03.060 Preliminary plat approval period.

The approval or conditional approval shall be valid for not more than three calendar years. At the end of this period the AGB may, at the request of the subdivider, extend the approval for a mutually agreed upon period of time. Any mutually agreed-upon extension must be in writing and dated and signed by the members of the governing body and the subdivider or the subdivider's agent. The AGB may issue more than one extension.

After the preliminary plat is approved, the governing body may not impose any additional conditions as a prerequisite to final plat approval, providing the approval is obtained within the original or extended approval period described above (MCA § 76-3-610(2)).

After the preliminary plat is approved, and the developer requests changes the planning director or designee shall evaluate the request as described in Section 16.11.040.

(Ord. No. O17-01, § 16.3.6, 3-7-2017)

16.03.070 Appeal process.

A decision of the governing body regarding a proposed subdivision may be appealed to district court, as provided MCA § 76-3-625.

(Ord. No. O17-01, § 16.3.7, 3-7-2017)

16.03.080 Final plat.

A final plat application shall be submitted for review and approval following the procedures outlined in Section 16.03.130 of this chapter prior to the expiration of the preliminary plat approval period.

(Ord. No. O17-01, § 16.3.8, 3-7-2017)

16.03.090 First minor subdivision from a tract of record.

Divisions of land creating five or fewer lots from a tract of record that has not been subdivided or created by a subdivision under the Montana Subdivision and Platting Act or has not resulted from a tract of record that has had more than five parcels created from that tract of record under MCA § 76-3-201 or MCA § 76-3-207 since July 1, 1973 shall be reviewed as a minor subdivision, hereafter referred to as a "first minor" (MCA § 76-3-609). The requirement of holding a public hearing or submitting an environmental assessment does not apply to first minors (MCA § 76-3-609(2)(d)(ii)). Unless the subdivision lies within an area that has adopted zoning regulations, the application must include a draft findings of fact (MCA § 76-3-609(2)(c)).

First minors have to meet the same preapplication meeting requirements as major subdivisions.

- A. First Minor Preliminary Plat Application Submittal. Complete and sufficient application for first minor preliminary plat approval shall be made to the planning director or designee. When the date of submittal falls on a weekend or holiday, the submittal shall be on the following working day.

The application form and supplemental documents are available in the appendices of these regulations. For first minor subdivisions a draft findings of fact must be prepared by the subdivider as part of the submittal. No public hearing or environmental assessment is required.

- B. Review Period. Upon receipt of a complete application, the AGB has thirty-five working days to approve, conditionally approve, or deny the preliminary minor plat application. The review period may be extended with consent of the subdivider provided either in writing or given during a public Planning Board meeting or public hearing.

(Ord. No. O17-01, § 16.3.9, 3-7-2017)

16.03.100 Subsequent minor subdivisions.

Divisions of land creating five or fewer lots that are not first minor subdivisions shall be reviewed as major subdivisions (MCA § 76-3-609(4)).

The application form, accompaniments, and review processes are the same as for major subdivisions. (Ord. No. O17-01, § 16.3.10, 3-7-2017)

16.03.110. Subdivisions qualifying for expedited review.

- A. Eligibility. Subdivisions, hereafter referred to as "expedited review plats" containing one or two parcels are eligible for expedited review when:
 - 1. They meet the definition of a first minor subdivision from a tract of record;
 - 2. Legal and physical access to all lots is provided;
 - 3. No land in the subdivision will be dedicated to public use for parks or playgrounds;
 - 4. The plat has been approved by DEQ or county environmental health whenever approval is required; and
 - 5. No public improvements are required.
- B. Preapplication Meeting Required.
- C. Expedited Review Plat Application Submittal.
 - 1. Required. The subdivider shall submit to the planning director or designee, for review and recommendation to the AGB, a checkprint of the final plat and all accompaniments.
 - 2. Checkprint. Prior to submitting the final plat on mylar, a subdivider must submit six copies of a final plat application, six paper prints of the final plat, six draft copies of the supporting documents to the planning director or designee for review. The final plat application form is provided in Appendix H "Expedited Final Plat Application" and the form and content of the checkprint and the supporting documents are described in Appendix J "Final Plat Requirements." The final plat review fee and the subdivision title commitment or title report are also required at this stage.
- D. Final Plat and Supporting Documents Contents and Submittal Copies. The subdivider shall submit one electronic copy in .pdf, .jpg or .tif format and if available, one copy in either AutoCad[®] or ArcGIS[®] format. The subdivider must also submit one signed mylar original of the final plat. The form and content of final plat is provided in Appendix J "Final Plat Requirements." The final plat must be accompanied by a complete expedited review plat application form as provided in Appendix H "Expedited Final Plat Application," a subdivision title commitment or title guarantee prepared within the previous six months, all supporting documents, and the required review fee.
- E. Review Procedure. The planner shall route the application, final plat, and supporting documents to the appropriate city and county departments and officials for their signatures within sufficient time to assure the documents are placed on the first available agenda of the AGB for their consideration and authorized signatures.
- F. Governing Body Action. At a regularly scheduled meeting, the AGB shall consider the following information in deciding whether to approve or deny a final plat:
 - 1. The effect on agriculture, agricultural water user facilities, local services, the natural environment, wildlife and wildlife habitat, and public health and safety (MCA § 76-3-608 (3)(a));

-
2. Consistency with the adopted Growth Policy and Bike/Ped Plan; and
 3. These subdivision regulations.
 4. The governing body shall give due weight and consideration to the subdivider's expressed preferences (MCA § 76-3-608(5)(b)). The governing body may not deny approval of a subdivision based solely on the subdivision's impacts on educational services (MCA § 76-3-608(1)), or based solely on compliance with the Growth Policy (MCA §76-3-605(2)(b)).
 5. In the event the governing body denies the final plat, it shall send a letter to the subdivider stating the reasons for the denial along with written findings of fact (MCA § 76-3-608(4)).
 6. After all required signatures have been obtained; the plat shall be recorded with the county clerk and recorder within twelve (12) months of the date of approval.

(Ord. No. O17-01, § 16.3.11, 3-7-2017)

16.03.120 Amended plats.

- A. Required. A division of lots within a platted subdivision filed with the county clerk and recorder that redesigns or rearranges six or more lots must be reviewed and approved by the governing body and an amended plat must be filed with the county clerk and recorder (MCA § 76-3-207(2)(a)).
- B. Eligibility. Amended plats shall be processed as first minor subdivisions if they meet the following criteria:
 1. Legal and physical access to all lots is provided;
 2. No land in the subdivision will be dedicated to public use for parks or playgrounds; and
 3. The plat has been approved by DEQ or county environmental health whenever public drainage, or water and sewer systems are required.
 4. Amended plats not meeting these criteria shall be reviewed as major subdivisions.
- C. Form and Content. An amended plat shall be entitled "Amended Plat" and follow the form and content shown in Appendix D "Preliminary Plat Requirements."

(Ord. No. O17-01, § 16.3.12, 3-7-2017)

16.03.130 Final plat submittal requirements.

- A. Required. After receiving a preliminary plat approval for a major, first minor, or subsequent minor, the subdivider may submit a final plat of the proposed subdivision. The final plat shall incorporate all required conditions and changes and conform to the approved preliminary plat and this section.
- B. Checkprint. Prior to submitting the final plat on mylar, a subdivider must submit six copies of a final plat application, six paper prints of the final plat and six draft copies of the supporting documents to the planning director or designee for review. The final plat application form is provided in Appendix I "Final Plat Application" and the form and content of the checkprint and the supporting documents are described in Appendix J "Final Plat Requirements". The final plat review fee and the subdivision title commitment or title report are required at this stage. The planning director or designee may require additional documentation to ascertain whether the conditions of preliminary plat approval have been met.

The planner shall notify in writing the subdivider no later than fifteen working days after receipt of the checkprint of any changes required.

-
- C. Final Mylar Submittal. Application for final plat approval shall be submitted to the planning director or designee at any time. The subdivider shall submit one electronic copy in .pdf, .jpg or .tif format and if available, one copy in either AutoCad ® or ArcGIS ® format. The subdivider must also submit two signed mylar original of the final plat. The form and content of final plat is provided in Appendix J "Final Plat Requirements." The final plats must be accompanied by a complete final plat application form as provided in Appendix I "Final Plat Application"
 - D. Review Procedure. The planner shall review the check print and accompanying documents for compliance with the conditions for approval from the AGB. If in compliance the planner shall obtain the required signatures from city or county officials and forward the final plat to the county clerk and recorder.
 - E. Approval Period. After the governing body has approved the plat and all required signatures have been obtained, the plat shall be recorded with the county clerk and recorder within twelve months of the date of approval.

(Ord. No. O17-01, § 16.3.13, 3-7-2017)

Chapter 16.04 DEVELOPMENT REQUIREMENTS

Sections:

16.04.010 General.

All subdivisions approved by the governing bodies must comply with the provisions of this chapter, except where granted a variance pursuant to Section 16.11.010, Variances, of these regulations. The requirements contained in this chapter apply to subdivisions within the area of the Laurel-Yellowstone City-County Planning Board.

(Ord. No. O17-01, § 16.4.1, 3-7-2017)

16.04.020 Conformance with zoning.

In addition to the standards outlined in this chapter, the design and development of a subdivision must conform to any applicable Laurel zoning regulations as found in Title 17 of the Laurel Municipal Code. If there are conflicting requirements between these regulations and the zoning regulations the most restrictive standards shall apply.

(Ord. No. O17-01, § 16.4.2, 3-7-2017)

16.04.030 Improvement design.

Engineering and survey plans, specifications, and reports required in connection with public improvements and other elements of the subdivision required by these regulations must be prepared by a professional engineer or professional land surveyor as their respective licensing laws allow in accordance with the Montana Subdivision and Platting Act (MSPA) and these regulations.

(Ord. No. O17-01, § 16.4.3, 3-7-2017)

16.04.040 Lots.

- A. Regulation of Lots. Each lot must contain a building site that conforms to Yellowstone City-County Health Department regulations, the Laurel Building Code where applicable, the regulations of this chapter, and other applicable State or local regulations. Lots must also be in conformance with zoning regulations.
- B. Dimensions, Orientation, and Topography. The lot size, depth, shape, and orientation shall be appropriate for the location, contemplated use of the subdivision, and the zoning of the property. Areas within the subdivision with a slope of twenty-five percent or greater shall be identified on the face of the preliminary and final plats.
- C. Frontage. Residential, commercial, and industrial lots shall have frontage on a public right-of-way, public road easement, or private easement. The lots size shall be in conformance with any applicable zoning regulations. For those subdivisions located outside of the zoning jurisdiction, all lots shall have a minimum of thirty-two feet of frontage on a public right-of-way, public road easement, or private easement. The planning department may require greater frontage for subdivisions that are commercial and industrial in nature.
- D. Division by Rights-of-Way. No single lot may be divided by a public road, alley, or access easement unless a valid variance is first obtained subject to the variance procedures provided for in these regulations.
- E. Rural Lot Limitations. Residential or commercial lots not served by public sewer or public water systems shall not be less in area than what is required by DEQ regulations. There is nothing contained in this chapter that shall be construed as preventing DEQ or Yellowstone City-County Health Department from requiring that all or any portion of a subdivision shall not be built upon, or that the proposed lot sizes must be increased to ensure protection of public health.

Subdivisions that are developing in the county but are within the city of Laurel zoning jurisdiction, or in close proximity to a public water or sewer system, shall consider in designing water and/or sewer systems the future connection to the public systems. Designing the systems to connect to a public system is not a requirement but may better facilitate future annexation of existing development or extension of services to a development from a public system.

- F. Corner Lots. Design of corner lots must meet the following requirements:
 - 1. Corner lots must be of sufficient size to provide a building site while meeting the clear vision requirements specified in the most current American Association of State Highway and Transportation Officials (AASHTO) Manual guidelines. Corner lots must also be of sufficient lot size and in conformance with zoning as it relates to minimum lot size and setbacks, if applicable.
 - 2. Residential corner lots adjacent to a street identified as a principal or minor arterial must have vehicular access only to an internal street in the subdivision identified as a collector or residential street, except when limited by topography or other physical constraints of the property.
- G. Double Frontage Lots. Double frontage lots (see Figure 2.1 in Section 16.02.010) are allowable when they are necessary due to topography and when a one-foot wide no-access easement (to be shown on the plat) is provided for separation of residential development from railroad or major street rights-of-way.
 - 1. Residential Areas: For any residential subdivision where an arterial street abuts or runs through any portion of the subdivision, the subdivision plan shall provide for lots to back up to the arterial street and provide a one-foot wide no-access easement to prevent vehicle access to the arterial street.
 - 2. Commercial Areas: For any commercial subdivision where an arterial street abuts or runs through any portion of the subdivision, the subdivision plan shall provide for shared accesses to the arterial street or access via internal roads with a one-foot wide no-access easement to prevent uncontrolled vehicle access to the arterial street.

(Ord. No. O17-01, § 16.4.4, 3-7-2017)

16.04.050 Blocks.

- A. Size and Orientation. Length, width, and shape of blocks shall be determined with consideration of the following:
 - 1. Provision of adequate building sites suitable to the needs of the type of use contemplated;
 - 2. Needs for convenient and necessary access, circulation, traffic control and traffic safety, and public safety; and
 - 3. Limitations or opportunities created by the topography.
- B. Rights-of-Way for Internal Non-motorized Connections. Public rights-of-way for internal non-motorized connections within blocks will be required when needed to provide circulation or safe access to schools, parks, playgrounds, shopping, transportation, and other community facilities. Pathways or sidewalks shall also be installed from the end of cul-de-sacs or dead ends to the property boundary of the subdivision to make connections to other cul-de-sacs or streets in adjacent neighborhoods, where deemed appropriate by the AGB.
- C. Block Numbering. All blocks shall be identified with Arabic numerals.

(Ord. No. O17-01, § 16.4.5, 3-7-2017)

16.04.060 Streets and roads.

- A. Road Network Performance Standards. When evaluating a subdivision's road network, subdividers and reviewing agencies shall take into consideration the following criteria. These criteria were developed to ensure that all new lots are provided access that is safe, convenient, and effective for future lot owners. The proposed road network shall also enable emergency service providers to protect life and property under emergency situations.
 - 1. Every lot shall have documented legal and physical access.
 - 2. Physical access shall be provided in conformance to the standards found in the subdivision regulations and any other applicable regulations such as zoning, Montana Public Works Standards, City of Laurel Standards for Public Works Improvements and the City of Laurel Rules and Regulations governing Streets when applicable.
 - 3. There shall be right-of-way and road connections made when existing roads or platted roads outside of the subdivision connect to the subject parcel.
 - 4. Proposed roads shall be looped or connected to other roads whenever possible. Exceptions can be made when there are topographic features that prevent connections or when the legal status of the road prevents connection.
 - 5. Dead end roads and/or driveways greater than one hundred feet in length must have an approved turn-around at their terminus.
 - 6. Major and subsequent minor subdivisions that exceed an aggregate of 5 lots shall have two points of access.
 - 7. Dead end roads shall not be more than one thousand feet in length.

(Supp. No. 20)

Created: 2023-10-23 14:37:24 [EST]

8. When access roads cannot be installed as required above in #6 & #7 due to location on property, topography, waterways, nonnegotiable grades or other similar conditions, the fire department having authority may recommend additional fire protection measures, including, but not limited to, the installation of a secondary fire apparatus access road, additional water supply, widening of roads, and/or additional pullouts or turnarounds.

Figure 16.4.A.1. Road Network Evaluation Flowchart

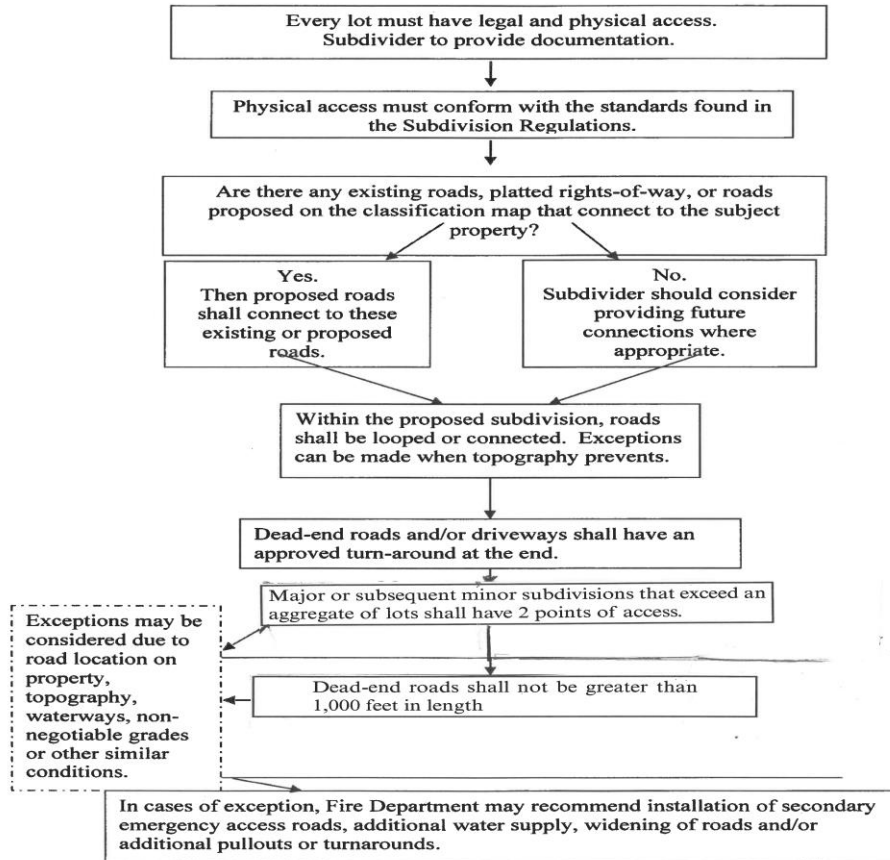

- B. Streets and Roads, General. The arrangement, type, extent, width, grade, and location of all streets shall conform to any adopted area plans including, but not limited to, the Growth Policy and the Bike/Ped Plan and must be considered in their relation to existing and planned streets, topographical conditions, public convenience and safety, and the proposed uses of the land to be served by them.
 1. Relation to Undeveloped Areas: When a proposed subdivision adjoins undeveloped land, streets within the proposed subdivision shall be arranged to allow access to the adjoining undeveloped land. Street right-of-way within the proposed subdivision shall be provided to the boundary lines of the tract to be developed, unless prevented by topography or other physical conditions.

-
2. Relation to Developed Areas. The subdivider shall arrange the streets to provide for the continuation of streets between adjacent developed properties when such continuation is necessary for the convenient movement of traffic, effective provision of emergency services, and efficient provision of utilities. Such provision may be waived where the adjacent land use is incompatible with the proposed subdivision, or when prevented by topography or other physical conditions.
 3. Separation of Through and Local Traffic. Whenever a subdivision abuts or contains an existing or proposed highway, Arterial street, or Collector street, the subdivider may be required to provide frontage roads, reverse frontage lots with a no-access strip preventing access along the rear property lines, planting or fencing screens, shared accesses, or other treatment as may be necessary to adequately protect residential properties and to separate through and local traffic.
 4. Distance between Parallel Right-of-Way. Where a subdivision borders on or contains a railroad, limited access highway, canal, stream or ditch right-of-way, the subdivider shall be required to provide a street or easement approximately parallel to and on each side of the right-of-way at a distance sufficient to allow for the operations and maintenance of the intervening land. Such distances shall also be determined with regard for the requirements of approach grades and future grade separation.
 5. Second Access: To facilitate traffic movement, the provision of emergency services, and the placement of utility easements, all major subdivisions shall provide a minimum of two access roads built to the standards of this chapter to all lots in the subdivision. Provision of a second access may be required for first minor or subsequent minor subdivisions when deemed necessary for the health, safety, and welfare of the new lot owners. If a second access cannot be provided for reasons of topography or other physical conditions, the subdivider shall provide an emergency secondary access road, built to the standards detailed in Section 16.04.120 of these regulations.
 6. Dead-end Roads. Dead-end access roads or driveways in excess of one hundred fifty feet shall not be permitted without an approved turn around at the terminus. Where such roads or driveways terminate, the subdivider shall provide a cul-de-sac or "hammerhead-T" turnaround conforming to the design standards outlined in Figure 16.4.C.3. In cases where a dead-end road may be extended in the future, a right-of-way easement or dedication may be required to be provided.
 7. Right-of-Way and Street and Road Developments. In all cases, the right-of-way must be provided when developing the property. If the property is being developed on only one side of an existing or proposed road or street and dedicated right-of-way or a road easement is required, the property owner developing must secure the additional right-of-way or easement from the adjacent property owner. If the additional required right-of-way or easements cannot be secured, the developer must provide the full width of right-of-way on the subject property.

When the development is located in the Laurel zoning jurisdiction, the property developing must build the sidewalk, swale, and portion of the shoulder and roadway as determined by the county public works department to meet the applicable road design standards. The additional improvements on the remaining portion of the right-of-way or road easement will be constructed at the time the adjacent property develops.

8. Street Continuity. Streets that are a continuation of streets in contiguous territory shall be so aligned as to assure that their centerlines shall coincide and shall have matching names. In cases where straight continuations are not physically possible, such centerline shall be continued by a centerline offset of not less than one hundred twenty-five feet.
9. Tangent for Reverse Curves. A tangent shall be introduced where necessary between reverse curves on arterial and collector streets as determined by a professional engineer.
10. Deflected Street Lines to be Curved. When continuing street lines deflect from each other at any one point by more than five degrees, they shall be connected by a curve with a radius adequate to ensure

stopping sight distance at the center line of a street in accordance with the most current American Association of State Highway and Transportation Officials (AASHTO) Manual guidelines.

11. Intersections. Local streets shall be laid out so as to intersect as nearly as possible at right angles and no local street shall intersect any other local street at less than eighty degrees. Such angle of eighty degrees or greater shall be retained for at least fifty feet back from the intersection. Any street intersection involving an arterial and/or collector streets shall intersect at ninety degrees, shall be retained for at least one hundred feet back from the intersection. Not more than two streets shall intersect at any one point unless warranted by design by a professional engineer and reviewed by the appropriate public works department.
 12. Lot Corners at Intersections. Lot corners at all road intersections shall be rounded with a minimum radius of ten feet when the proposed subdivision is located outside of the city of Laurel's zoning jurisdiction.
 13. Sight Distance. The alignment of all streets and roads must provide adequate sight distances in accordance with the most current AASHTO Manual guidelines. Intersections must be designed to provide adequate visibility for traffic safety based on the designed operating speeds of the intersecting roadways.
 14. Approach Permits. The subdivider shall obtain the applicable approach or access permits for all new accesses to city and county roads. For any new vehicular access onto a State controlled road or highway, the subdivider shall obtain an approach permit approved by the Montana Department of Transportation (MDT).
 15. Street/Road Names and Addressing. New streets/roads aligned with existing streets/roads shall have the same name as the existing street/road. All new street/road names shall be approved by the Yellowstone County GIS Department prior to final plat approval in order to avoid duplication and confusion with names of existing roads. Lot addresses are assigned by county GIS.
 16. Street/Road Signs and Traffic Control Devices. Street or road signs and traffic control devices of the size, shape, and height in conformance with the standards contained in the Manual on Uniform Traffic Control Devices must be placed at all intersections by the subdivider.
 17. Central Mail Delivery. When required by the U.S. Postal Service, the developer must provide a cluster/gang mailbox for mail delivery.
 18. Road Design and Improvement Standards. All streets and roads, existing or proposed, within and adjacent to a proposed subdivision shall meet the design and improvement standards outlined in Subection C of this section.
 19. Street/Road Maintenance: For all subdivisions not located within city limits or proposed for annexation, the subdivider shall establish a new rural special improvement district or expand an existing adjacent RSID prior to final plat approval to provide funds for ongoing maintenance of all new public improvements associated with the subdivision. These improvements may include, but not be limited to, new roads, bridges, culverts, street signs, sidewalks, pathways and any other public improvements resulting from the subdivision.
- C. Design and Improvement Standards for Subdivisions.
1. General. The design and improvement standards contained in this section shall apply to all construction and reconstruction of streets and roads within subdivisions.
 2. Improvement Design. All street improvements shall be designed by and constructed under the supervision of a professional civil engineer. All improvements shall meet or exceed the right-of-way and construction standards for the type of street to be constructed found within these regulations and adopted policies of the city and county public works departments as appropriate.

-
3. Plans and Specifications. A complete set of professionally certified plans and specifications shall be provided to the appropriate public works department prior to initiation of any street improvement construction. The subdivider shall provide professional engineering services for construction inspections and post-construction certifications. Record drawings shall be submitted to the appropriate public works department upon completion of construction.

Post construction certifications shall include, but not be limited to, the following:

- a. Compaction test results;
 - b. Certification that all required improvements are complete;
 - c. Certification that the subdivider knows of no defects from any cause in those improvements;
 - d. Certification that these improvements are free and clear of any encumbrance or lien;
 - e. The method by which the one year guarantee is to be provided; and
 - f. A schedule of actual construction costs shall be filed with the appropriate public works department.
4. Traffic Impact Study. Prior to AGB action on a preliminary plat, a traffic impact study shall be prepared by a professional engineer, with proven competence in traffic engineering and submitted with the preliminary plat for any new major residential, institutional, commercial, or industrial development located within city limits and the zoning jurisdiction. All other proposed subdivisions which will generate five hundred or more vehicular trips per day per the most recent standards of Trip Generation from the Institute of Transportation Engineers shall also be required to provide a traffic impact study. A vehicular trip is defined as a one-way journey of a person in an automobile or a transit vehicle. If the study indicates a need for the installation of traffic signals, intersection improvements, or other off-site street improvements to facilitate traffic flow generated by the entire proposed development, the subdivider shall be responsible for his/her proportional share of those improvements. The study shall include, but not limited to the following:
 - a. Estimated number of vehicular trips per day;
 - b. Location of approaches;
 - c. Circulation patterns;
 - d. Location and type of traffic control devices;
 - e. Pedestrian safety;
 - f. Projected turning movements; and
 - g. Impacts on existing street intersections.
 5. Offsite Requirements: When determining a developers proportionate share of off-site improvements the following shall apply:
 - a. Payment for Other Costs Directly Attributable to the Subdivision. When any road or segment of road impacted by the subdivision will not meet or exceed the local jurisdictions road standards at the time of full build out of the subdivision, the governing body shall require the subdivider to pay or guarantee payment of the costs of improving the road so that it meets the local standards. The subdivider shall be required to pay or guarantee payment of costs that reflect the expected impacts directly attributable to the subdivision, as described below. If an engineer, licensed in the State of Montana, certifies that the road or segment of road affected by the proposed subdivision will meet or exceed the applicable road standards at full build out of the subdivision,

the subdivider shall not be required to contribute to the cost of improving that road or segment of road.

- b. Determining Costs Directly Attributable to the Subdivision. A preliminary engineering report (PER), prepared and certified by an engineer licensed in the State of Montana shall provide estimated costs of improvements necessary to make a road or segment of road meet or exceed the local road standards. The PER shall describe the existing and proposed conditions of the impacted road facility. Estimated costs shall include the following:
- i. Estimated preliminary and final engineering costs including, but not limited to, design plans and specifications, material testing during construction, inspection and administration;
 - ii. Estimated costs of obtaining and completing necessary permits;
 - iii. Estimated surveying costs;
 - iv. Estimated right-of-way acquisition costs;
 - v. Estimated utility relocation costs;
 - vi. Estimated costs for geotechnical and miscellaneous design related site testing and laboratory analysis; and
 - vii. Estimated costs for road construction/improvements including materials, turning lanes, horizontal alignment and vertical grade adjustments, construction staking, temporary and permanent erosion control, road subgrade stabilization including geotextiles and subbase, sidewalks, curb and gutter, topsoil salvage and replacements, revegetation, weed management, traffic signals, traffic signal timing changes, temporary traffic control, traffic control, approaches, bridges, guardrails, signage and/or pavement markings, non-motorized facilities, provisions for stormwater drainage, and contingencies to bring the facility into compliance to these regulations.
- c. Estimated costs for any other items necessary to improve the road. Estimated costs shall not be older than six months at the time of final plat application. The burden of proof for estimate costs is the responsibility of the subdivider. Estimate costs must be prepared and certified by an engineer licensed in the State of Montana. Estimated costs shall be submitted to the appropriate road and bridge or public works department for review and recommendation. The governing body may, at the subdivider's expense, require a third party, designated by the governing body, to review estimated costs as described in the PER.

With preliminary approval of the subdivision application, the governing body shall determine a percentage of the costs described above by comparing projected annual average daily traffic (AADT) at full build out of the subdivision with existing AADT. The percentage of costs shall be calculated for each segment of road impacted using the following formula

$$\frac{P - E}{P} * 100 = I$$

(P-E)

Where:

P = Projected AADT

E = Existing AADT

I = Percentage of Impact

- d. Use of Funds. Upon receipt of funds related to estimated costs, the County shall place funds in an interest bearing reserve account, held and used by the county strictly for the impacted roads or segments of road within the subdivision's impacted area.
5. Street and Road Right-of-Way Dedication. All streets or alleys within, or providing access to, the proposed subdivision shall be dedicated to the public and accepted by the AGB except when an approved public access easement or private road is provided in accordance with these Regulations.
6. Access Easements. Where access to or within a subdivision is proposed using access easements the subdivider must obtain or provide proper easements of sufficient width to satisfy the requirements of Table 16.4C.1. The easement shall meet the following:
- a. Easements must be granted by all property owners whose land the easement(s) cross in a signed and notarized document to be recorded with the final plat.
 - b. The location of any road easement must be shown on the plat if it is within the subdivision or on a supplemental exhibit if it is off site. The existence of easements must be noted on the face of the final plat and on any deeds or other instruments conveying lots within the subdivision.
 - c. All newly created easements shall be written so that they are easements appurtenant that run with the benefited land and shall clearly define whether the easement will allow further burden to the easement and the extent of the further burden to the easement.
7. Private Roads. Private roads may be allowed within a subdivision. A private road easement shall be provided meeting the criteria listed under Section 16.04.060.C above. A mechanism for maintenance of any private roads shall be established prior to final plat approval.
8. Right-of-Way and Street Widths. Street right-of-way and surface widths for all roads, public or private, including those located in the Laurel zoning jurisdiction with the exception of those zoned Agricultural Open and Residential Suburban shall be provided as shown in Table 16.4.C.1 below.

Street right-of-way and surface widths for all roads, public or private, on property in the Agricultural Open Space (A-O) and Residential Suburban Zoning Districts or outside of the Unified Zoning Jurisdiction shall be provided as shown in Table 16.4.C.1.

Table 16.4.C.1. Required Dedications and Street Improvements for Subdivisions

Street Type	Right-of-Way	Road Width	Lane Width	Parking Width	Turn Lane Width	Median Width	Sidewalk Minimum Width
Principal Arterial							
6 lanes w/ center turn-lane	120'	92'*	12'/14'**	—	14'	—	5'
4 lanes w/ center turn-lane	120'	92'*	12'/14'**	—	14'	—	5'
Minor Arterial							
4 lanes w/ median	100'	68'*	12'	—	—	14'	5'
2 lanes w/ median	100'	52'*	12'	—	—	14'	5'
Commercial Collector							
2 lane	80'	44'*	14'	8'	—	—	5'
2 lanes w/ center turn lane	80'	42'*	14'	—	14'	—	5'
Residential Collector							
2 lane	70'	40'*	12'	8'	—	—	5'

2 lanes w/ center turn lane	80'	50'*	12'	8'	14'	—	5'
Residential Local Access	67'	28'	12	n/s	—	—	5'
Cul-de-Sac 100-600 feet	67'	28'	12	n/s	—	—	5'
Cul-de-Sac <100 feet	40'	24' min.	10	n/s	—	—	—

* Widths to be provided if warranted by a Traffic Accessibility Study.

** Interior lane(s) is twelve feet and the outside lane is fourteen feet.

*** Roads in the Agricultural Open Space or Residential Suburban Zoning Districts, or roads outside of the Zoning Jurisdiction will be built 28' wide to include 24' driving surfaces, 2' shoulders, and drainage swales (See Figure 16.4.C.2. or (See Figure 16.4.C.3.). All roads within the Zoning Jurisdiction, except for those in the Agricultural Open Space or Suburban Residential Zoning Districts, will be built 34' wide to include 24' driving surfaces, 5' shoulders, and drainage swales (See Figure 16.4.C.1).

n/s No width is specified.

9. Shoulders. Shoulders shall be required on both sides of all roads where no curb and gutter or parking lanes are required (county subdivisions only). The shoulders shall be two feet wide and graveled, and must meet the specifications of the Yellowstone County Public Works Department.
10. Alleys. Proposed alleys in both residential and commercial subdivision shall meet the following standards:
 - a. The width of an alley shall be a minimum of twenty feet.
 - b. Alley intersections and sharp changes in alignment shall be avoided, but where necessary, corners shall be designed to permit single unit truck movement.
 - c. Dead-end alleys shall be avoided where possible, but if unavoidable, shall be provided with adequate turnaround facilities at the end.
11. Grading/Cut and Fill. All streets and alleys within or adjacent to the subdivision shall be excavated or filled to the grade established by these Regulations.
12. Base Construction: The type of base required will vary depending on the nature of the existing material and with the particular type of traffic to be accommodated and shall be approved by the appropriate public works department prior to use. (See Figures 16.4.C.1. and 2.)
13. Street Surfacing: All roads within or adjacent to the subdivision shall be paved where they connect to an existing paved road. All roads within or adjacent to the subdivision may be graveled where the connect to an existing graveled road. The standards for such surfacing shall be according to city or county specifications unless otherwise warranted by engineering design. (See Figures 16.4.C.1. & 16.4.C.2)

Figure 16.4.C.1.

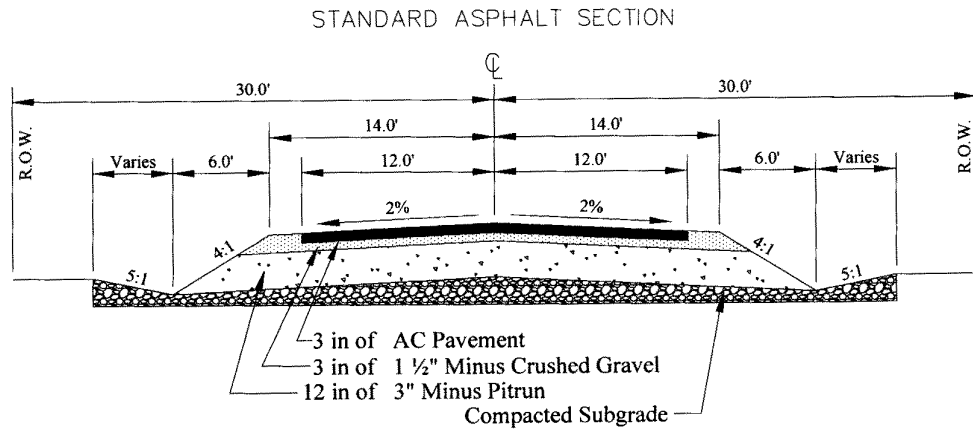
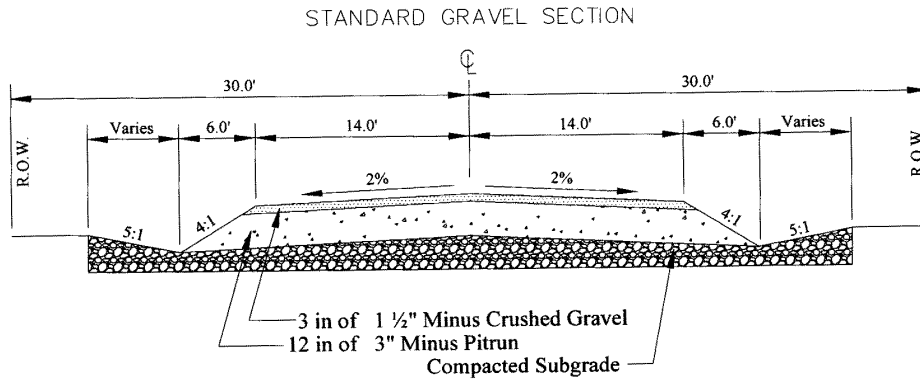

Figure 16.4C.2.



Street Grades. All street grades shall conform to the requirements of the city or county. Street grades shall not exceed the following, with due allowance for reasonable vertical curves and intersection treatment.

Street Type	Percent Grade
Arterial	4
Collector	7
Local Access	12

15. Pedestrian and Sidewalk Connections: Sidewalks shall be installed with all streets within the Laurel zoning jurisdiction with exception of those properties zoned Agricultural Open and Suburban Residential. Required pathway widths shall follow those listed in Table 16.4.C.1. and meet the appropriate governing body public works standards.
16. Access Driveways: Access driveways are defined as an access serving one or two lots and not more than five dwellings. Accesses serving more than two lots or five dwellings shall be considered a road, and shall be built to the road standards outlined in these regulations. An approach permit is required for all new access driveways. New driveways shall meet the following standards:

In residential subdivisions, the maximum driveway width shall be thirty feet. The minimum distance between driveways shall be twenty-five feet or as otherwise allowable by the public works director for the city of Laurel and Yellowstone County

In commercial and industrial subdivisions, the maximum driveway width may be up to fifty feet when approved by the AGB. The minimum distance between driveways shall be twenty-five feet.

In any allowable location, no driveway width shall be less than twelve feet wide.

Only one driveway shall be provided to any single residential lot unless otherwise approved by the AGB or designee. Additionally, in cases where a lot fronts on a collector or arterial road currently carrying or projected to carry more than five hundred vehicles trips per day or where site distances warrant, the AGB may require shared access drives among lots. The AGB may permit more than one driveway for commercial lots.

In cases where an access driveway is in excess of one hundred feet in length (by variance), it shall have a minimum unobstructed width of twenty feet, and shall have an approved turn-around at its terminus. (See Figure 16.4.C.3 for acceptable design standards for turn-arounds.)

Figure 16.4.C.3. Access Driveway Acceptable Turnarounds

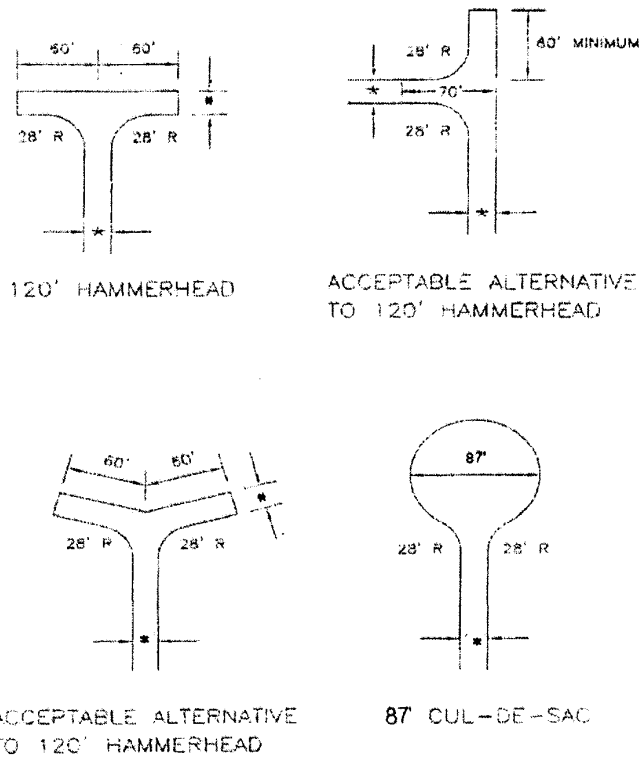

*** Width as Required by Table 23-406.B.1**

* = Twenty (20) feet minimum unless otherwise required.

- D. Multi-Use Trails, General: When applicable, subdivisions shall be reviewed for consistency with the Bike/Ped Plan to provide multi-use trail routes for safe, convenient, non-motorized transportation routes throughout the planning area.

-
1. It is recommended that all new subdivisions provide a twenty-foot-wide multi-use trail easement across the property if the Bike/Ped Plan indicates that a proposed multi-use trail route crosses the subdivision property.
 2. If the Bike/Ped Plan indicates that a proposed trail route crosses the subdivision property, and a segment of the corridor has already been provided on adjacent property, then the subdivision shall provide a twenty-foot wide trail easement to connect to the trail segments at the property lines to provide for a continuous trail route.
 3. When parkland dedication is required and the Bike/Ped Plan indicates that a proposed trail route crosses the subdivision property, dedication of linear park land including a trail easement may be considered as all or a portion of the required parkland dedication. (See Section 16.10.030 of these Regulations)

(Ord. No. O17-01, § 16.4.6, 3-7-2017)

16.04.070 Storm drainage facilities.

- A. General: Facilities and design for storm water drainage shall be provided in accordance with standards set by DEQ. If there is no existing storm drainage system in the area or if the existing system has insufficient capacity to carry the additional discharge, the subdivider shall provide an on-site area for retention or detention with controlled outlet capacity, if needed. The final DEQ approved storm water management plan for all subdivisions shall be provided with the final plat and recorded as part of the final DEQ documents when the final plat is recorded.
- B. Drainage Discharge: Discharge of storm drainage is subject to the following:
 1. Storm drain systems shall not discharge into sanitary sewer facilities.
 2. Storm drain systems shall not discharge into agricultural water user's facilities without the written permission of the appropriate irrigation district.
 3. Storm water detention or retention ponds may be located within public parkland at the discretion of the AGB. Such areas shall not count toward the parkland dedication requirement unless they are approved by the park board and the AGB, designed to serve as an amenity to the park, and fit into the planned uses and improvements to the park. (See Section 16.10.040 of these regulations.)
- C. Easements: Easements may be required between lots and along public rights-of-way to manage storm drainage in subdivisions.
- D. Location of Facilities: If any onsite retention or detention facility is used it shall be included as part of the lots, public right-of-way, or parkland. No separate parcels shall be created exclusively for such facilities.
- E. System Maintenance: If any onsite retention or detention facilities are utilized, unless otherwise provided, a special maintenance district or rural special improvement district shall be created prior to filing the final subdivision plat in order to provide funds for the maintenance of such facilities.
- F. Future Improvements: If any onsite retention or detention facility is used, a waiver of right to protest the creation of a future storm drain system special improvement district shall be executed by the subdivider and recorded and filed with the final plat.

(Ord. No. O17-01, § 16.4.7, 3-7-2017)

16.04.080 Sanitary sewer and water systems.

- A. If any boundary of the subdivision is within five hundred feet of a public sanitary sewer or water system, the subdivider must connect to the public sewer or water and install sanitary sewer and/or water system facilities in accordance with the requirements of the sewer or water district involved and the standards of DEQ.

The governing body, upon determination from the DEQ, may grant a waiver of the requirement to connect to a public system if the subdivider demonstrates that connection to the public system is physically or economically impractical or if the district or utility refuses to provide service. For purposes of this section, a connection is economically practical if the cost is less than or equal to three times the cost of installation of an approvable system on the site.

In cases where a waiver is granted and also if the boundary of the subdivision is more than five hundred feet from sanitary sewer services, the subdivider will sign a waiver of right to protest future sanitary sewer infrastructure improvements and assessments.

- B. Where individual septic systems or water wells are proposed, the systems must, at a minimum, meet the standards set forth in Montana Administrative Rules, Title 17, Chapter 36 (Subdivisions/Onsite Subsurface Wastewater Treatment) and obtain approval from DEQ, if less than twenty acres in size, or by the Yellowstone County Environmental Health Department if over twenty acres in size.

(Ord. No. O17-01, § 16.4.8, 3-7-2017)

16.04.090 Utilities.

- A. All new utilities serving the subdivision including electricity, cable television, and telephone shall be placed underground, with the exception of fire hydrants, cable closures, alignment markers, etc. Easements for utilities shall be clearly indicated on the plat.
1. Easements across lots or centered on common rear or common side lot lines shall be provided for public utilities and shall be at least sixteen feet wide; easements located along perimeter lot lines shall be at least eight feet in width. The width of an easement may vary depending upon the utility company serving the subdivision.
 2. Utility facilities shall be designed by utility firms in cooperation with the subdivider, subject to applicable laws and rules and regulations of any appropriate regulatory authority having jurisdiction over such facilities.
- B. Where a subdivision is proposed partially or wholly within Laurel's airport influence area, a perpetual air rights easement shall be executed and submitted with the plat.

(Ord. No. O17-01, § , 3-7-2017)

16.04.100 Watercourse and irrigation easements (MCA § 76-3-504(1)(j)(k)(l)).

- A. Easements for Irrigation Facilities Within the Subdivision: Easements are required to be shown by metes and bounds on the face of the preliminary and final plats for all drainage ways, irrigation canals/ditches and their laterals, and below-ground pipelines that traverse the property to be subdivided and for the future use of the subdivision lot owners or homeowners' association.
- B. *Easements Through the Subdivision for the Benefit of Downstream Water* users: Easements are required to be shown by metes and bounds on the face of the preliminary and final plats for all drainage ways, irrigation

canals/ditches and their laterals, and below-ground pipelines on the property being subdivided that are necessary to convey water through the subdivision to lands adjacent to or beyond the subdivision boundaries in quantities and in a manner that is consistent with historic and legal rights. In addition, an easement document shall be recorded with the final plat. The easements provided shall meet the following standards:

1. Easements shall be provided in locations of appropriate topography and sufficient width to allow the physical placement and unobstructed maintenance of open ditches or below ground pipelines for the delivery of water for irrigation to persons and land legally entitled to the water under an appropriated water right or permit of an irrigation district or other private or public entity formed to provide for the use of the water right on the subdivision lots;
2. Easements of a sufficient width to allow for construction, repair, maintenance, and inspection of the ditch shall be provided. The easement width shall be based on the policy of the appropriate irrigation district; and
3. The easement document shall prohibit the placement of structures or the planting of vegetation other than grass within the ditch easement without the written permission of the water users.

C. Additional Provisions:

1. The realignment or relocation of active irrigation ditches or pipelines is discouraged when said facilities are located outside of public right-of-way. If an irrigation facility is proposed to be realigned or relocated, the developer shall obtain written permission of the appropriate irrigation district and/or water user and the subdivider's professional engineer shall certify prior to final plat approval that the water entering and exiting the realigned or relocated irrigation facility is the same quality and quantity that entered or exited the facility prior to realignment or relocation.
2. New storm water generated from a subdivision shall not be discharged into an irrigation facility unless the subdivider receives written approval from the appropriate agricultural water user facility prior to final plat approval.

D. Irrigation Drainage:

1. Easements are required to be shown by metes and bounds on the face of the preliminary and final plats for all drainage ways.
2. Irrigation drainage ditch must have easement and written permission to cross property owned by others.

E. Additional Provisions: Additional provisions regarding irrigation drainage are as shown in Section 16.04.100(C) above.

(Ord. No. O17-01, § 16.4.10, 3-7-2017)

16.04.110 Disposition of water rights (MCA §76-3-504(j)(i)).

If a subdivision will create lots averaging less than five acres in size, the subdivider shall submit evidence with the final plat indicating that either A. and B., below, or C., below, has been provided:

- A. **Reservation and Transfer of Water Rights:** The subdivider shall reserve all or a portion of the water rights on the land to be subdivided and transfer these water rights to a single entity for use by landowners within the subdivision who have a legal right to the water. Any remaining surface water rights from the land shall be reserved and severed; and
- B. **Establish Landowner's Water Use Agreement:** If the land to be subdivided is subject to a contract or interest in a public or private entity formed to provide for the use of a water right on the subdivision

lots, the subdivider shall establish a landowner's water use agreement administered through a single entity. This agreement must specify how the water rights will be administered and describe the rights and responsibilities of landowners within the subdivision who have a legal right and access to the water; or

- C. All Rights Reserved and Severed: All surface water rights shall be reserved and severed from the land proposed for subdivision.

(Ord. No. O17-01, § 16.4.11, 3-7-2017)

16.04.120 Fire protection requirements.

To ensure a reasonable level of fire protection and life-safety for the public and firefighters, an approved water supply capable of the required water flow for fire protection shall be provided, in accordance with this section and the applicable fire code, to all premises upon which facilities, buildings, or portions of buildings are hereafter constructed or moved into the jurisdiction.

- A. Definitions:

"Approved:" Acceptable to the Laurel Volunteer Fire Department.

"Dry hydrant system:" A permanent piping system with an underground static water supply which provides year-round, frost-free access to a water source other than a pressurized municipal water source.

"Exposure:" Any structure more than two hundred square feet in size.

"Residential dwellings:" Residential occupancies where the occupants are primarily permanent in nature and where buildings do not contain more than two dwelling units, or child care facilities that provide accommodations for five or fewer persons of any age for less than twenty-four hours. This shall include buildings arranged for occupancy as residential care/assisted living facilities including more than five but not more than sixteen occupants, excluding staff.

- B. Minor Subdivisions: For all minor subdivisions creating three to five lots, the subdivider shall provide a minimum of one of the following mechanisms for fire suppression:

1. A pressurized fire hydrant system meeting the flow requirements of the applicable Fire Code and National Fire Protection Association (NFPA) 1142.
2. An approved, single, minimum ten thousand-gallon underground water storage tank with approved dry hydrant type fittings located not more than one-half road mile from the furthest structure in the subdivision. If an approved existing underground water storage tank is located within one-half road mile from the furthest structure of the proposed subdivision, it may be used to meet this requirement. In either case, the dry hydrant shall be constructed to the standards set forth by this section.
3. Any other method reviewed and approved by the Laurel Fire Department having jurisdiction and the AGB.

- C. Major, Commercial, and Subsequent Minor Subdivisions. The subdivider shall provide a minimum of one of the following mechanisms for fire suppression:

1. A pressurized fire hydrant system meeting the flow requirements of the applicable Fire Code and NFPA 1142.
2. An approved, single, minimum thirty thousand-gallon underground water storage with approved dry hydrant type fittings located not more than one-half road mile from the furthest structure in the subdivision. If an approved existing underground water storage tank is located within one-

half road mile from the furthest structure of the proposed subdivision, it may be used to meet this requirement. In either case, the dry hydrant shall be constructed to the standards set forth by this section.

3. Any other method reviewed and approved by the Fire Department and the AGB.
- D. Dry Hydrant Specifications: If the dry hydrant option for fire suppression is utilized, the hydrant shall be constructed to the following standards:
1. All dry hydrant systems shall be designed and constructed to provide a minimum flow of one thousand gallons per minute (gpm) of draft.
 2. Dry hydrants shall have a minimum clearance of twenty feet on each side and be located a minimum of one hundred feet from any structure. Approved pullouts or other design features shall be constructed to ensure that highway or road traffic shall not be impaired during use of the dry hydrant.
 3. Dry hydrants shall be located to be accessible under all weather conditions.
 4. The water container shall be a clean fiberglass or concrete tank, approved by the fire department.

To ensure safety of design, functionality, installation, maintenance, and proper appropriation of financial resources, the Laurel Fire Department shall approve all aspects of tank location, construction design, type of materials, pipe, and system fittings.

- E. Water supply maintenance: The subdivider shall establish a rural special improvement district (RSID) prior to final plat approval that ensures the continual operation and maintenance of the water supply system.

All underground water supply tanks shall be available for use by any fire department responding to any fire within the jurisdiction where the fire is occurring.

- F. Emergency Secondary Access Roads: In the event that an emergency secondary access road is approved as a means of providing a second access to a subdivision, as required by Section 16.04.060 of these regulations, it shall be built to the following standards:
1. Emergency access roads shall be designed to a minimum unobstructed surface width of not less than twenty feet and shall be constructed to adequately support a forty-ton vehicle with a surface so as to provide all weather driving capabilities. The road shall be constructed to county standards (see Figure 16.4.F.1). Where requested by the fire department, gates or other approved barricades shall be required at either end of the road to restrict through-traffic. A sign shall be fixed to each gate in a conspicuous manner. The sign shall read "EMERGENCY ACCESS ONLY" using black letters not less than two inches wide and six inches high on a white retro reflective background.
 2. Prior to construction, a cross-sectional design of the road including location, section, surfacing, and drainage, and design of gates or barriers shall be submitted to and approved by the Laurel Fire Department and an engineer licensed in the State of Montana. The storm drain design shall accommodate runoff during a ten-year storm event to ensure that there is no blockage of the roadway in the event of an emergency. The drainage shall not encroach into the travel way.
 3. Emergency access roads will be assigned a name by the Laurel Fire Department. In order to ensure the roads are entered into and reflected on the county GIS mapping system, the road shall be shown on the plat along with the name assigned to the road. Emergency access roads will not have conventional street signs identifying them by the assigned name.

4. One set of final plans showing corrections/revisions after review and approval shall be submitted to the fire department, and one set of final plans shall be provided to county GIS to ensure that the emergency access road and road name are entered into the GIS mapping system.

Figure 16.4.F.1

EMERGENCY SECONDARY ACCESS ROAD SECTION

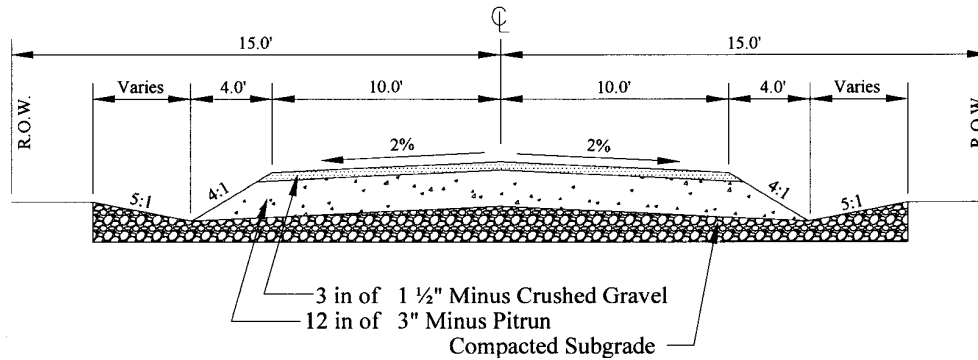

(Ord. No. O17-01, § 16.4.12, 3-7-2017)

16.04.130 Noxious weed control.

In order to comply with the Montana County Weed Control Act, Title 7, Chapter 22, Part 21, Mont. Code Ann., all proposed city and county subdivisions must enter into a weed management plan agreement with the county weed board. Approval of the final plat will be contingent on a weed board-approved weed management and included in the subdivision's SIA.

Subdivision weed management plans require completion of application forms obtained from the Yellowstone County Weed Control Department, a site map that will allow for inspection of the proposed development, and payment of the inspection fee prior to performance of the required inspection.

Mitigation of any identified existing noxious weed species will be required as well as planned re-vegetation of all disturbed areas within the proposed subdivision.

(Ord. No. O17-01, § 16.4.13, 3-7-2017)

16.04.140 Flood hazard evaluation.

If any portion of a proposed subdivision is within the floodway of a flood of one hundred-year frequency as defined by Title 76, Chapter 5, Mont. Code Ann. and the Federal Emergency Management Agency (FEMA), or deemed subject to flooding by the county, or if any portion of a proposed subdivision is within two thousand horizontal feet and less than twenty vertical feet of a live stream draining an area of twenty-five square miles or more, the flood hazard evaluation criteria found in Appendix O shall be applied, as appropriate.

(Ord. No. O17-01, § 16.4.14, 3-7-2017)

Chapter 16.05 GUARANTEE OF PUBLIC IMPROVEMENTS

16.05.010 Subdivision improvements agreement (SIA).

Prior to granting approval of the final plat by the AGB the subdivider shall have installed all of the required improvements as stipulated in these regulations, and shall, at the time receiving approval of the final plat, enter into a written SIA which shall be filed concurrently with the clerk and recorder. The SIA is an agreement with the developer and the AGB guaranteeing the construction and installation of all required improvements in conformance with all adopted policies, standards and resolutions. The agreement shall stipulate, among other things, which type of security arrangements and timetable acceptable to the AGB the subdivider elects to use, the subdivider's plans for accomplishing the required improvements, and an agreement that the subdivider shall guarantee all improvements for a period of one year from the date of acceptance by the AGB. (See Appendix K for SIA Template.)

(Ord. No. O17-01, § 16.5.1, 3-7-2017)

16.05.020 Security guarantee.

The subdivider shall provide a monetary security guarantee from the following methods in the amount of one hundred twenty-five percent of the estimated total cost or actual construction contract amount of installing all required improvements including engineering and administration fees, as estimated by a professional engineer and approved by the appropriate public works department.

- A. Irrevocable Letter of Credit. The subdivider shall provide, from a financial institution or other reputable institution subject to the approval of the AGB or designee, an irrevocable letter of credit (See Appendix M for letter of credit template). This letter shall be deposited with the AGB and shall certify the following:
 - 1. That the creditor does guarantee funds of the required amounts, as estimated by the subdivider's professional engineer and approved by the appropriate public works department, for completing all required improvements;
 - 2. That, in the case that the subdivider fails to complete the specified improvements within the required time period, the creditor shall pay to the AGB immediately, and without further action, such funds as are necessary to finance the completion of those improvements, up to the limit of credit stated in the letter;
 - 3. That the letter of credit may not be withdrawn, or reduced in amount, until released by the AGB or designee; and
 - 4. That the letter of credit shall be renewed from year to year until such time the improvements are completed.
- B. Bond. The subdivider shall provide a surety bond to guarantee the funds to complete improvements, subject to any requirements of the bonding company. The bond shall be payable to the AGB and shall remain in effect until the improvements have been completed and accepted by such governing body. The subdivider shall bear all costs associated with the provision of the guarantee.
- C. Sequential Development. Where a subdivision is to be developed in phases, a phasing plan shall be prepared by the subdivider, and reviewed and approved by the AGB with the preliminary plat. The phasing plan shall be included in the SIA and shall describe which lots are included in each phase, what improvements shall be completed with each phase, and the approximate completion date of each phase. Improvements included in the first phase shall be constructed or guaranteed using one of the acceptable monetary security guarantees prior to final plat approval by the AGB. Lots within subsequent phases shall be restricted from being transferred or developed. A "Restrictions on

Transfers and Conveyances" contract shall be entered into for subsequent phases by the subdivider and the governing body and shall be filed with the final plat documents with the clerk and recorder (see Appendix N for restrictions of transfers and conveyances template). A release on the restrictions on transfers and conveyances may be filed with the clerk and recorder only after the necessary improvements for each particular phase are constructed, approved, accepted by the AGB, or guaranteed using one of the acceptable monetary security guarantees.

(Ord. No. O17-01, § 16.5.2, 3-7-2017)

16.05.030 Reduction of guarantees.

The amount of the approved guarantee may be reduced upon installation and acceptance by the AGB of the required improvements. The amount of the reduction shall not exceed the percentage that the accepted improvements made up of all originally required improvements.

(Ord. No. O17-01, § 16.5.3, 3-7-2017)

16.05.040 Release of guarantee.

Upon completion of required improvements by the subdivider and acceptance of them by the AGB, all in conformance with this chapter, the AGB shall authorize the release of any remaining portion of the improvement guarantee up to 90% of the original amount. The remaining ten percent will be released after any deficiencies are corrected after the one-year warranty inspection.

(Ord. No. O17-01, § 16.5.4, 3-7-2017)

Chapter 16.06 DEVELOPMENTS FOR RENT OR LEASE

16.06.010 General.

- A. Purpose. A development providing multiple spaces for rent or lease for recreational vehicles (RV's) and mobile or manufactured homes is created when any portion of a parcel is rented or leased for the purposes of situating a temporary or permanent RV, mobile, or manufactured home for residential or commercial structure owned by the renter or lessee. The rented/leased land is owned as one parcel under single ownership, which can include a number of persons owning the property in common. These developments are commonly known as mobile/manufactured home parks and recreation vehicle parks.
- B. Review and Approval Required. Developments created by rent or lease are exempt from surveying and final plat filing requirements but mobile/ manufactured home parks and rv parks must be submitted for review by the planning board and approval by the AGB before portions thereof may be rented or leased (MCA §76-3-208). Approval is based on the criteria found in Chapter 16.03 of these regulations with the addition that the preliminary and final plans for subdivisions for rent or lease shall show the following:
 - 1. A layout of all spaces proposed for rent or lease.
 - 2. Location of common areas and facilities.
 - 3. Parks and/or recreation areas.
 - 4. Landscaping plan if required by these regulations.
 - 5. In lieu of a final plat, subdivider shall submit an unsurveyed final plan drawn to scale.

(Supp. No. 20)

Created: 2023-10-23 14:37:25 [EST]

-
- C. Zoning Requirements. Mobile/manufactured home parks and RV parks, within the Laurel zoning jurisdiction must comply with zoning regulations. If a development for rent or lease will require a zone change or a zoning variance, those application are to be submitted, reviewed and approved, conditionally approved or denied prior to submission of an application for development for rent or lease. For purposes of these types of developments, setback requirements shall follow the development requirements outlined in Subsection 16.06.020.A.

(Ord. No. O17-01, § 16.6.1, 3-7-2017)

16.06.020 Mobile/Manufactured home and RV park development requirements.

A. Manufactured Home/RV Spaces.

1. The number of allowed spaces is limited to what is approved on the final plan.
2. Spaces must be arranged to permit the safe and practical placement and removal of manufactured homes.
3. All manufactured homes/RVs must be located a minimum of twenty feet from all perimeter boundary lines.
4. The manufactured home pad must be located at least ten feet from the street that serves it.
5. Location of space limits on the ground must be approximately the same as those shown on the approved plans. Precise surveying of space limits is not required either on the plans or on the ground.
6. The size of the manufactured home pad must be suitable for the general market to be served and must fit the dimensions of manufactured homes anticipated. At a minimum the pad should measure fourteen feet wide and seventy feet long. All pads shall be constructed of at least six inches of gravel over a stabilized sub-base.
7. The total area occupied by a manufactured home and its roofed accessory buildings and structures may not exceed one-third of the area of a space.
8. All manufactured homes/RV's shall be separated by a minimum of fifteen feet.
9. There shall be a minimum of fifteen feet between all attached structures such as carports, awnings, decks, and stairs and any adjacent manufactured home.
10. There shall be a minimum of six feet between detached structures and any adjacent manufactured home. Detached structures are defined as any structure that is more than six feet away from the manufactured home.
11. A minimum of two off-street parking spaces must be provided on or adjacent to each manufactured home space. The driveway must be located to allow for convenient access to the manufactured home, and be a minimum of ten feet wide.
12. One guest parking space must be provided for each five manufactured home spaces. Group parking may be provided.
13. The density of a recreational vehicle park may not exceed twenty-five recreational vehicle spaces per acre of gross site area.

B. Streets.

1. All streets within a manufactured home or RV park shall be private.

-
2. Private streets shall be designed to provide access to all sites. No site shall have vehicular access to a public street. The streets shall be laid out to discourage through traffic and intersections with public streets shall be kept to a minimum.
 3. Streets may be designed for no on-street parking, on-street parking on one side only, or on-street parking on both sides. All streets shall be paved to a typical crown section, an invert section, or a straight warp section. All streets shall bordered on at least one side by either a sidewalk of a minimum width to meet the current Americans with Disabilities Act (ADA) standards or a pedestrian pathway.
 4. The minimum pavement width for streets with no on-street parking shall be twenty feet.
 5. The minimum pavement width for streets with on-street parking on one side shall be twenty-eight feet.
 6. The minimum pavement width for streets with on-street parking along both sides shall be thirty-six feet.
 7. Curvilinear streets shall have no centerline curve with less than a one hundred-foot radius. At intersections, the inside edge of the paved street shall have a minimum of a twenty-foot radius.
 8. All streets shall intersect at an angle of ninety degrees except where the subdivider has obtained a variance from the AGB.
 9. The layout near street intersections shall be such that a clear vision area is maintained. Stopping sight distance on curves shall be as required on subdivision streets.
 10. All traffic-control devices used shall comply with the current edition of the Manual on Uniform Traffic Control Devices.
- C. Fire Protection.
1. All manufactured home/RV parks shall be located within a local fire district or fire service area.
 2. The manufactured home park shall provide an adequate water supply for fire suppression needs, following the requirements as found in Section 16.04.120 of these regulations. The means for fire protection shall be subject to approval by the local fire district and the AGB.
- D. Health Standards/License Requirement. In addition to the criteria of these Regulations, manufactured home and RV parks must also meet the minimum standards of the Montana Department of Public Health and Human Services (MDPHHS) under Title 50, Chapter 52, Mont. Code Ann. and the requirements of the Montana Department of Environmental Quality (MDEQ) under Title 50, Chapter 60, Mont. Code Ann. The AGB shall not grant final approval of a manufactured home and/or recreational vehicle park until the subdivider first obtains the applicable licenses and approvals for the facility from MDPHHS and MDEQ.
- E. Additional Provisions.
1. Manufactured home/RV parks shall meet the parkland dedication requirements as outlined in Chapter 16.10 of these regulations.
 2. Parks located adjacent to industrial, commercial, or lower-density residential land uses shall provide screening such as fences or natural growth along the property boundary lines separating the community from such adjacent uses.
 3. Parks shall have a sign near the main entrance showing the park layout.
 4. Centralized mail delivery shall be provided at one or more location within the park. Location and design of such group mail collection site(s) shall be reviewed and approved by the U.S. Postal Service and the appropriate public works department.

-
5. It shall be unlawful to operate a manufactured home/RV park without holding a valid, annual license issued by the MDEQ

(Ord. No. O17-01, § 16.6.2, 3-7-2017)

Chapter 16.07 CLUSTER DEVELOPMENTS AND PLANNED NEIGHBORHOOD DEVELOPMENTS (MCA §76-3-509)

16.07.010 Purpose.

The purpose of this chapter is to promote maximum flexibility in the design of new developments and to encourage innovation within a framework of timely, efficient, and flexible design review. Developments that utilize innovative, progressive planning and site design techniques and methods to allow a mixture of land uses, densities, setbacks, and building heights are encouraged. Cluster developments are encouraged where community resources are present and desirable for protection or preservation. Those areas include but are not limited to wildlife habitat, river and stream corridors, wetlands, historical or archeological sites, or prime agricultural lands. Planned neighborhood developments are encouraged where the proposed development is in excess of twenty acres and diversity in land uses is desirable.

(Ord. No. O17-01, § 16.7.1, 3-7-2017)

16.07.020 Definitions.

"Cluster development": A cluster development is a subdivision creating five or more lots clustered in a group that is designed to concentrate building sites on smaller lots in order to reduce capital and maintenance costs for infrastructure via concentrated public services and utilities while allowing other lands to remain undeveloped. A minimum of thirty percent of the area within the subdivision shall be reserved for open space owned by common ownership (MCA §76-3-103(2)).

"Master plan": A master plan is a site plan for a planned neighborhood development that shows lots, blocks, streets, alleys, and areas for various land uses including open space within the development. The master plan shall be part of the subdivision approval and any significant change to such master plan shall be considered an amended subdivision.

"Maximum density calculation": The maximum number of residential dwelling units is calculated by dividing the gross square footage of the cluster development area (including any open space area) by the required lot area in the underlying zoning district. In cases where lots are not zoned, the maximum density shall be calculated by dividing the gross area of the property by the minimum lot area to meet the MDEQ standards.

"Planned neighborhood development": A planned neighborhood development (PND) is a subdivision consisting of a planned mixture of land uses such as residential clusters, industrial parks, shopping centers, and/or office building parks built in a prearranged relationship to each other and having open space and community facilities in common ownership or use (MCA §76-3-103(10)).

(Ord. No. O17-01, § 16.7.2, 3-7-2017)

16.07.030 Cluster development general requirements.

- A. Cluster development may be applied to any residential subdivision of five or more lots. The subdivision shall generally conform to the growth policy and the underlying zoning district(s) although the lots may be smaller in area than required in the underlying zoning district.
- B. The maximum size of any developed parcel or lot within a cluster development is one hundred seventy-five thousand square feet.
- C. A minimum of thirty percent of the total area within the subdivision shall remain undeveloped in a cluster development. The undeveloped parcel(s) must be protected in perpetuity to prohibit further division of the parcel.
- D. Cluster developments are exempt from the review criteria in Chapter 16.03 of these regulations (MCA §76-3-509(e)(ii)) and from the parkland dedication requirements in so far as the cluster development meets or exceeds parkland dedication requirements.

(Ord. No. O17-01, § 16.7.3, 3-7-2017)

16.07.031 Design standards and applications for cluster developments.

- A. The cluster development subdivision shall follow all applicable review procedures, as outlined in Chapter 16.03 of these regulations.
- B. Site Analysis Map. If an environmental assessment is required as part of the preliminary plat application it should include the following information on a site analysis map:
 - 1. Property boundaries;
 - 2. All streams, rivers, lakes, wetlands and other hydrologic features;
 - 3. Topographic contours with a minimum of five-foot intervals; where lots are proposed on slopes ten percent or less, contours must be shown at two-foot intervals;
 - 4. All proposed open space areas;
 - 5. General vegetation characteristics;
 - 6. General soil types;
 - 7. The planned location of protected open space;
 - 8. Existing roads and structures; and
 - 9. Potential connections with existing open space, parks and trails.
- C. Open Space Management Plan. An open space management plan, as described in Section 16.07.031(G) of this chapter, shall be prepared and submitted with the preliminary plat application. This plan will be reviewed as a supporting document of the preliminary plat. Review and recommendations to the governing body on the proposed open space management plan will be prepared by the planner.
- D. Instrument of Permanent Protection Required. An instrument of permanent protection as detailed in MCA § 76-6-101 et seq., the Open-Space Land and Voluntary Conservation Easement Act, shall be provided for the open space concurrent with the application for final plat approval.
- E. Maximum Density. The maximum number of dwelling units shall be calculated by dividing the gross area of the subject property, including the open space, by the required lot area of the underlying zoning district. In the case where the subject property is not zoned, the maximum density shall be calculated by dividing the

gross area of the property by the minimum lot area to meet MDEQ standards. Unless prohibited by MDEQ standards, the applicant need not demonstrate the development capability of the land to calculate the maximum dwelling unit density.

- F. Other Requirements. The applicant shall adhere to requirements of the underlying zoning district(s) with the exception of minimum lot area per dwelling unit (see maximum density above). The proposed number of dwelling units shall not exceed the maximum density, but each dwelling unit may be placed on a lot of less than the minimum lot area required by the underlying zoning district(s).
- G. Open Space.
1. At least thirty percent of the gross area of a cluster development shall be reserved as open space.
 2. Resource Protection Areas. The following are considered resource protection areas and are required to be included within the open space when present. These resource areas must be mapped and shown on the preliminary plat.
 - a. The 100-year floodplain.
 - b. Riparian zones of at least seventy-five feet in width along all perennial and intermittent streams.
 - c. Wetlands that meet the definition used by the Army Corps of Engineers pursuant to the Clean Water Act.
 - d. Populations of endangered or threatened species, or habitat for such species.
 - e. Archaeological sites, cemeteries and burial grounds, or historic sites listed as such with any state or federal agency.
 3. Other Resource Areas. The following are considered important resource areas and may or may not be included within the open space at the discretion of the subdivider.
 - a. Historic sites or structures not listed as such with state or federal agencies.
 - b. Existing native forests or prairie of at least one-acre contiguous area.
 - c. Other significant natural features and scenic view sheds such as ridgelines, peaks and rock outcrops, particularly those that can be seen from public roads.
 - d. Prime agricultural lands of at least two contiguous acres.
 - e. Existing trails that connect the tract to neighboring areas.
 - f. Areas at the base of any ridgeline or rimrock of at least one contiguous acre.
 4. Above-ground utility rights-of-way and small areas of impervious surface may be included within the protected open space. Such areas shall make up not more than five percent of the required open space area.
 5. At least seventy-five percent of the open space shall be in a contiguous tract of a minimum size of one acre. The open space should adjoin any neighboring areas of open space, other protected areas, and non-protected natural areas that would be candidates for inclusion as part of a future area of protected open space.
 6. The open space should be directly accessible to the largest practicable number of lots within the subdivision. Non-adjoining lots shall be provided with safe, convenient access to the open space.
 7. Uses of open space may include the following:
 - a. Conservation of natural, archeological or historical resources;

-
- b. Meadows, woodlands, wetlands, wildlife corridors, game preserves, or similar conservation-oriented areas;
 - c. Walking, bicycle trails, or other multi-use trails;
 - d. Passive recreation areas, such as open fields;
 - e. Active recreation areas;
 - f. Agriculture, horticulture, silviculture, or pasture uses, provided that all applicable best management practices are adhered to;
 - g. Landscaped storm water management facilities approved by the County, community wastewater disposal systems and individual wastewater disposal systems located on soils particularly suited to such uses;
 - h. Easements for drainage, access, and underground utility lines; and
 - i. Other conservation-oriented uses compatible with the purposes of this Section.
8. Prohibited uses of open space:
 - a. Golf courses;
 - b. Roads, parking lots, and impervious surfaces, except as specifically authorized in the previous sections;
 - c. Impoundments; or
 - d. Other activities as determined by the subdivider and recorded on the legal instrument providing for permanent protection.
 9. Ownership and Management of Open Space. Open space shall be owned by one of the following entities:
 - a. The open space may be dedicated to the public as public parkland. Acceptance of the open space shall be at the discretion of the governing body; or
 - b. A homeowners' association representing residents of the subdivision may own the open space. Membership in the association shall be mandatory and automatic for all homeowners within the subdivision and their successors. The homeowners' association shall have lien authority to ensure the collection of dues from all members.
 - c. Management Plan. The subdivider shall submit a plan for management of open space and common facilities that:
 - (1) Allocates responsibility and guidelines for the maintenance and operation of the open space and any facilities located thereon, including provisions for ongoing maintenance and for long-term capital improvements;
 - (2) Estimates the costs and staffing requirements needed for maintenance and operation of, and insurance for, the open space and outlines the means by which such funding will be obtained or provided;
 - (3) Provides that any changes to the management plan be approved by the planning department, or in the case of publicly owned open space, approved by the appropriate Governing Body; and
 - (4) Provides for enforcement of the Management Plan.
 - d. Maintenance.

-
- (1) Open space dedicated to the public shall be maintained according to the management plan by a park maintenance district (PMD) to be established prior to final plat approval.
 - (2) Open space owned by a homeowners' association shall be maintained according to the management plan by the homeowners' association. In the event the party responsible for maintenance of the open space fails to maintain all or any portion in reasonable order and condition, the AGB may assume responsibility for its maintenance and may enter the premises and take corrective action, including the provision of extended maintenance. The costs of such maintenance may be charged to the association, or to the individual property owners that make up the association, and may include administrative costs and penalties. Such costs shall become a lien on all subdivision properties.

10. Legal Instrument for Permanent Protection of Open Space.

- a. Privately owned open space shall be protected in perpetuity by a binding legal instrument that is recorded with the deed. The instrument for permanent protection shall include clear restrictions on the use of the open space. These restrictions shall include all restrictions contained in this Section as well as any further restrictions the applicant chooses to place on the use of the open space.
- b. Tax Assessment of Open Space. Once a legal instrument for permanent protection has been placed upon the open space, the county board of assessment shall be directed to reassess the open space at a lower value to reflect its more limited use. If the open space is used purely for passive recreational purposes and the terms of the instrument for permanent protection effectively prohibit any type of significant economic activity, then the assessment shall be at a value of zero.

(Ord. No. O17-01, § 16.7.3.1, 3-7-2017)

16.07.040 Planned neighborhood development general requirements.

A planned neighborhood development (PND) project is intended to encourage the use of improved techniques for the development and arrangement of a mixture of land uses more than is available under conventional zoning regulations or land restrictions that separate land uses into distinct zones. It is further the intent of PNDs to allow for the integration of housing, business and community facilities, and to allow for the preservation of the natural environment through efficient utilization of open space.

- A. A PND may be applied to any mixed use subdivision of five or more lots. The subdivision shall be generally consistent with the adopted growth policy. The underlying zoning district(s), land use designations, building setbacks, and other limitations shall be used as a general guide. The subdivider is encouraged to design the PND to allow a mixture of land uses, densities, setbacks and building heights.
- B. The maximum size of any proposed lot within a PND is three hundred fifty thousand square feet.
- C. The minimum size for any area designated for common use by the residents or owners within the PND or by the public is one contiguous acre. The area may be designated for active or passive recreation, for conservation purposes, or for any other use in common by the residents and owners of the PND or by the public.
- D. PNDs are exempt from the review criteria in Chapter 16.03 of these regulations and parkland dedication requirements in so far as the PND meets or exceeds parkland dedication requirements of Chapter 16.10
- E. PNDs shall comply with all other requirements of these regulations and shall be considered a special review use for purposes of the city zoning ordinance.

Created: 2023-10-23 14:37:25 [EST]

(Supp. No. 20)

16.07.050 Design standards and applications for planned neighborhood developments.

- A. The PND shall follow the applicable review procedures as outlined in Chapter 16.03 of these regulations. If an environmental assessment is required as part of the preliminary plat application, a site analysis map must be prepared and shall follow the same requirements as for cluster developments.
- B. PNDs are allowed in any zoning district as a special review use done concurrently with the preliminary plat application. The PND shall provide opportunities for mixed land uses, including housing types and densities, recreation, and neighborhood services such as schools, community centers, fire or police stations, libraries, and places of employment.
- C. Master Plan: A master plan must be submitted showing the proposed design and land use areas of the development. The master plan should be of sufficient detail to determine build-out population, traffic circulation and control requirements, permitted uses or mix of uses within each area, building envelopes for each developed lot, recreation areas, and open space. If open space is provided it shall conform to the requirements of 16.07.031(G).

The master plan must also show development phasing and construction timing for each phase of the subdivision including any construction or improvements for public parks, trails, community centers, fire and police stations, schools, or other public facilities that will serve the PND. Each development phase must contain mixed uses and housing densities. Common elements such as playgrounds, parks, neighborhood service areas, and community centers must be included for development within each phase of the development.

The PND must be consistent with the growth policy and other plans adopted by Laurel.

- D. Examples of Cluster Development Designs.

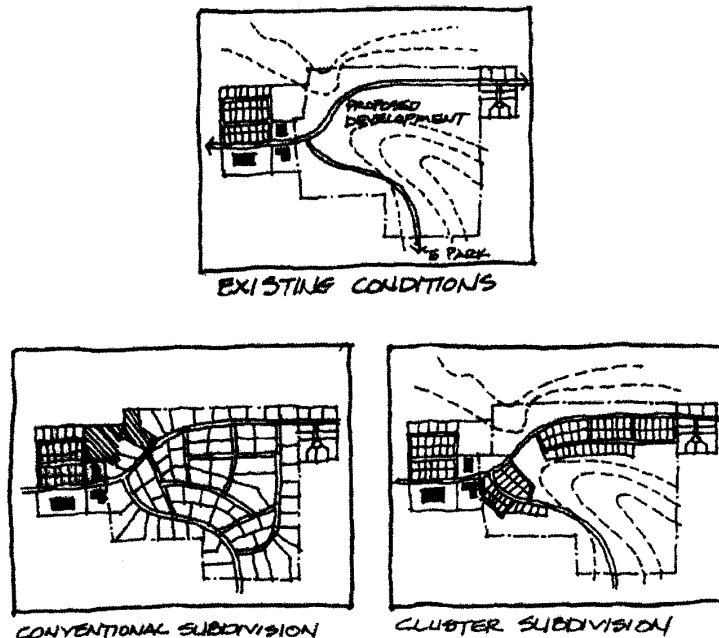

- E. Examples of Planned Neighborhood Developments Designs.

CARPENTER VILLAGE

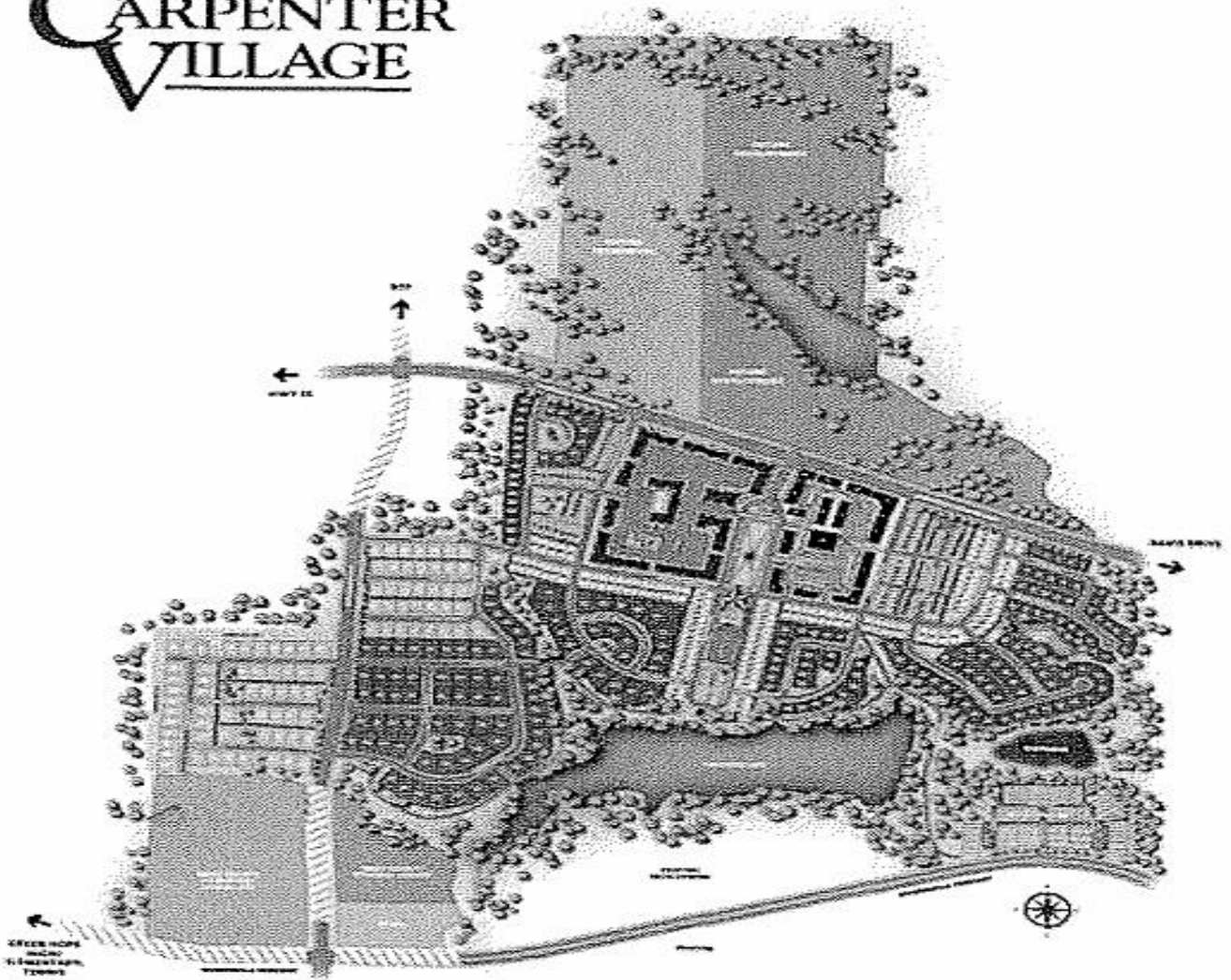

(Ord. No. O17-01, § 16.7.5, 3-7-2017)

Chapter 16.08 CONDOMINIUMS AND TOWN HOMES

16.08.010 Condominium development.

- A. Exemptions. All condominium developments are subdivisions subject to the terms of these regulations except those exempted by MCA §76-3-203 as described below.
 - 1. The approval of the original division of land expressly contemplated the construction of the condominiums, and any applicable park dedication requirements in MCA §76-3-621 are complied with;
or

-
2. The condominium proposal is in conformance with applicable local zoning regulations where local zoning regulations are in effect.
- B. Procedures. All condominium developments, which are not exempt from subdivision review are subject to the applicable procedures contained in Chapter 16.03, Subdivision Review Procedures or Chapter 16.06, Subdivisions for Rent or Lease. The applicable subdivision procedure will be based on:
1. Whether a division of land is to be created;
 2. The number of proposed units; and
 3. Whether the land is a first or subsequent minor subdivision.

(Ord. No. O17-01, § 16.8.1, 3-7-2017)

16.08.020 Town home development.

All town home developments are subject to the applicable procedures contained in Chapter 16.03 of these regulations and MCA §76-3-103(2). The applicable subdivision procedure will be based on:

- A. The number of proposed units; and
- B. Whether the land is a first or subsequent minor subdivision.

(Ord. No. O17-01, § 16.8.2, 3-7-2017)

16.08.030 Standards.

- A. Condominium and town home developments shall comply with those standards contained in Chapter 16.04, Development Requirements, and Chapter 16.10, Parks, Trails, and Open Space.
- B. All buildings and structures in a condominium or town home development shall be located at least twenty feet from the property line adjoining a public right-of-way or private access easement, and ten feet from all other perimeter property lines.
- C. Condominium developments shall comply with all applicable provisions of the Unit Ownership Act — Condominiums, Title 70, Chapter 23, Mont. Code Ann., as amended.

(Ord. No. O17-01, § 16.8.3, 3-7-2017)

Chapter 16.09 ENVIRONMENTAL ASSESSMENT.

16.09.010 Purpose.

The environmental assessment is a tool by which to evaluate a proposed subdivision's impact on the natural environment, adjacent properties, local services, and the community as a whole. From this evaluation the most appropriate course of action can be determined to mitigate any negative impacts created by the subdivision. The environmental assessment is required by MCA §76-3-603, unless otherwise exempted.

(Ord. No. O17-01, § 16.9.1, 3-7-2017)

16.09.020 General requirements.

- A. Major Subdivision. The subdivider shall provide an environmental assessment with the submittal of the preliminary plat containing the following information:
 - 1. A description of the surface and ground water, geology and soils, vegetation, and wildlife within the area of the proposed subdivision, as required by Section 16.09.030, Environmental Description Contents, of these regulations.
 - 2. A community impact report containing an analysis of anticipated impacts of the proposed subdivision on the community and local services as required by Section 16.09.040, Community Impact Report Contents, of these Regulations.
 - 3. A summary of probable impacts of the proposed subdivision based on the criteria described in MCA § 76-3-608 as required by Section 16.09.050, Summary of Probable Impacts, of these regulations.
 - 4. Additional relevant and reasonable information related to the applicable regulatory criteria per MCA § 76-3-501 as may be required by the AGB or designee.
- B. Subsequent Minor Subdivision. When a subsequent subdivision exceeds an aggregate of five lots from original tract of record an environmental assessment must accompany the preliminary plat and shall include only the summary of probable impacts of the proposed subdivision based on the criteria described in MCA § 76-3-608, as required by Section 16.09.050, Summary of Probable Impacts, of these regulations.
- C. Exemptions. The following subdivisions shall not be required to submit an environmental assessment:
 - 1. A first minor subdivision from a tract of record (MCA §76-3-609(3)).
 - 2. A subdivision qualifying for expedited review as described in Section 16.03.110 of these regulations.
 - 3. Other subdivisions that satisfy all of the following criteria (MCA § 76-3-608(7)):
 - a. The proposed subdivision is completely within an area adopted by the Growth Policy pursuant to MCA § 76-1-601, et seq.
 - b. The proposed subdivision is located within zoning pursuant to MCA § 76-2-201 through MCA § 76-2-328.
 - c. The proposed subdivision is located within an area where a long-range public works development program (i.e. Capital Improvements Plan) has been adopted.

(Ord. No. O17-01, § 16.9.2, 3-7-2017)

16.09.030 Environmental description contents.

- A. Surface Water.
 - 1. Locate on a plat overlay or sketch map all surface water and the delineated floodways that may affect or be affected by the proposed subdivision including natural water systems (streams, lakes, rivers, or marshes), artificial water systems (canals, ditches, aqueducts, reservoirs, irrigation or drainage systems), and land subject to flooding (see also Section 16.04.140 and Appendix O, Flood Hazard Evaluation).
 - 2. Describe all surface water that may affect or be affected by the proposed subdivision including name, approximate size, present use, and time of year that water is present.

-
3. Describe the proximity of proposed construction (such as buildings, sewer systems, roads) to surface water.
 4. Describe any existing or proposed stream bank or shoreline alterations and/or any proposed construction or modification of lakebeds or stream channels. Provide information on the location, extent, type, and purpose of any proposed alteration.
 5. Please indicate which of the following water quality permits have been or will be applied for and describe the reasons why these permits are required.

PERMIT AGENCY

310 Permit Local Conservation District

SPA 124 Permit Department of Fish, Wildlife and Parks

Floodplain Permit County Floodplain Administrator

Section 404 Permit, Section 10 Permit U. S. Army Corps of Engineers

318 Authorization Department of Environmental Quality

Navigable Rivers Land Use License or Easement

Department of Natural Resources and Conservation

B. Ground Water.

1. Using available information, provide the estimated seasonal minimum and maximum depth to the water table, dates on which these depths were determined, and the location and depth of all known aquifers that may be affected by the proposed subdivision.
2. Provide a description of any steps necessary to avoid the degradation of groundwater and groundwater recharge areas.

C. Geology/Soils/Slopes.

1. Using available information locate on a plat or overlay any known geologic hazards affecting the proposed subdivision which could result in property damage or personal injury due to any of the following: rock falls or slides; land, mud or snow slides; high water table, unstable or expansive soil conditions, slopes greater than twenty-five percent.
2. Explain the measures that will be taken to prevent or materially lessen the danger of future property damage or injury due to existing geologic hazards.
3. Provide a statement describing any unusual soil, topographic or geologic conditions on the property, which may limit the capability for construction or excavation using ordinary and reasonable techniques. The statement should address conditions such as shallow bedrock, high water table, unstable or expansive soil conditions, and slope. Describe the location and amount of any cut or fill three or more feet in depth. Where cuts or fills are necessary, describe prevention of erosion and the promotion of re-vegetation, such as replacement of topsoil and grading.
4. Include soil reports obtained from the USDA, Natural Resource and Conservation Service (NRCS) containing the physical properties and engineering indexes for each soil type, the soil limitations for sanitary facilities, building site development, and water features for each soil type. Describe any special design methods planned to overcome the soil limitations.

D. Vegetation.

1. Indicate the distribution of the major vegetation types and identify critical plant communities as identified by the NRCS.

-
2. Describe measures to preserve trees and critical plant communities (e.g., design and location of roads, lots and open spaces).
- E. Wildlife.
1. Describe species of fish and wildlife that inhabit the area affected by the proposed subdivision.
 2. Identify on an exhibit map any known critical or "key" wildlife areas, such as big game winter range, migration routes, waterfowl nesting areas, habitat for rare or endangered species, and wetlands.
 3. Submit the impacts of the proposed development on fish and wildlife as identified by the Montana Department of Fish, Wildlife, and Parks (MFWP). Provide a written statement outlining any recommendation of MFWP and any mitigation efforts to mitigate adverse impacts.

(Ord. No. O17-01, § 16.9.3, 3-7-2017)

16.09.040 Community impact report contents.

- A. Impact on agriculture and agricultural water user facilities.
1. Describe the number of acres in crop production and whether the property is in whole or in part a viable farm unit, e.g. was the property under production during the last regular season.
 2. Describe the uses of land within the vicinity of the proposed subdivision.
 3. Describe existing irrigation rights on the property and whether the rights will be transferred, retained by the original owner, or severed.
 4. Explain any modification or relocation of ditches or any easements to be provided with the subdivision. The subdivider shall notify the affected ditch company of the subdivision and shall obtain permission to reroute or alter the ditch in any way.
- B. Impact on local services and public health and safety.
1. Water Supply.
 - a. Describe how water will be provided for domestic use and fire protection.
 - b. Indicate the number of gallons per day of water the proposed subdivision will require and whether the water supply is sufficient to meet the needs of the anticipated population of the subdivision. Describe any anticipated effects on existing water systems or wells within the area.
 - c. Based on available information, specify whether the proposed water supply satisfies the standards set forth by MDEQ for quality, quantity and construction criteria.
 - d. If connection to an existing public, community, or shared water system is proposed, identify and describe the existing system and approximate distance to the connection from the proposed subdivision.
 - (1) Provide written evidence that permission to connect to that system has been obtained.
 - (2) Provide information regarding the capacity of the existing water system and its adequacy for serving the proposed subdivision.
 - e. If a new community or shared water system is proposed, identify who will install that system, and how the system will be maintained.
 - f. If individual water systems are proposed, describe the adequacy of supply of ground water for individual wells or cisterns and the method used to determine adequacy.

-
2. Sewage Disposal.
 - a. Describe the proposed method of sewage disposal.
 - b. Indicate the number of gallons of effluent per day that will be generated by the proposed subdivision at full occupancy, whether the proposed method of sewage disposal is sufficient to meet the anticipated needs of the subdivision, and whether it meets the standards of MDEQ.
 - c. If connection to an existing public sewer system is proposed, provide a description of the system and the approximate distance from proposed subdivision.
 - (1) Provide written evidence from the appropriate sewer jurisdiction granting permission to connect to that system shall be submitted with the preliminary plat.
 - (2) Provide information regarding the installation, maintenance, and phasing of any proposed public sewage disposal system.
 - d. If a new community or shared sewer system is proposed, identify who will install that system, and how the system will be maintained.
 - e. If individual septic systems are proposed, describe the location and specifications of septic systems.
 3. Solid Waste Disposal.
 - a. Provide evidence that there is an existing solid waste collection and disposal system available that can accommodate the anticipated additional volume.
 - b. If no existing collection and disposal system is available, describe the proposed method of solid waste collection and disposal.
 - c. Describe how the proposed system satisfies the standards set forth by MDEQ.
 4. Storm water.
 - a. Provide calculations indicating how much storm water run-off will be generated as a result of the proposed development.
 - b. Provide a description of the proposed storm water collection and drainage systems that satisfy the standards set forth by Section 16.04.070.
 5. Roads.
 - a. Describe any proposed access roads or substantial improvements to existing public or private access roads.
 - b. If connections to any existing roads are proposed, identify all access permits that are necessary from the city, county or state.
 - c. Discuss whether any of the individual lots or tracts have access directly to arterial roads.
 - d. Explain any proposed closure or modification of existing roads.
 - e. Describe provisions considered for dust control on roads.
 - f. Explain how road maintenance will be provided to meet MDEQ guidelines for prevention of water pollution and erosion.
 - g. Indicate who will pay the cost of installing and maintaining the roads.
 - h. Discuss how much daily traffic will be generated on existing local and neighborhood roads and main arterials when the subdivision is fully developed.

-
- i. Indicate the capacity of existing and proposed roads and if they are capable of safely handling the increased traffic resulting from the proposed subdivision. Describe any additional maintenance that will be necessary due to increased traffic and who will pay the cost of maintenance.
 - j. Indicate ownership of any private access to the subdivision, including private driveway easements.
6. Utilities.
- a. Indicate which utility companies are proposed to serve the subdivision.
 - b. State the method of furnishing electric, natural gas or telephone service, where provided, the extent to which these utilities will be placed underground, and the estimated completion of each utility installation.
 - c. Indicate if there are any existing utility lines on the property such as transmission lines, pipelines, etc. and if so, describe the impacts they may have on the proposed subdivision.
7. Emergency Services.
- a. Describe the emergency services available to the subdivision including fire protection, police protection, ambulance, and medical services.
 - b. Provide an estimate of the number of responses generated by the subdivision, and the method of determining those numbers.
 - c. Describe roads to the subdivision and provide information on compaction standards and widths that satisfy the requirements set forth for emergency vehicle access.
 - d. In the event that the proposed subdivision is located within the Wildland Urban Interface (WUI), the subdivider shall submit a plan to mitigate fire hazard in accordance with the fire department having jurisdiction.
 - e. Describe any health or safety hazards on or near the subdivision, such as mining activity, high-pressure gas lines, dilapidated structures or high voltage power lines. These conditions should be accurately described and their origin and location identified and any proposed mitigation.
8. Schools.
- a. Describe the available educational facilities that would service this subdivision.
 - b. Provide an estimate of the number of school children that will be generated from the proposed subdivision and provide the basis for the estimate.
 - c. Provide information regarding whether increased enrollment can be accommodated by the present personnel, facilities and the existing school bus system. This should include any recommendations of the administrator(s) and plans to mitigate adverse impacts of the proposed development on the provision of educational services.
9. Parks and Recreation Facilities.
- a. Describe any park and recreation facilities to be provided within the proposed subdivision and other recreational facilities that may serve the subdivision.
 - b. State how the required parkland dedication is being satisfied.
- C. Land Use.
- 1. Indicate compliance with zoning encompassing all or part of the proposed subdivision. If the proposed subdivision is located near the jurisdictional area of an incorporated city or town, state whether annexation is proposed.

-
2. Describe how the subdivision will affect access to any public lands. Where public lands are adjacent to or near the proposed development, describe present and anticipated uses for those lands.
 3. Describe the effect of the subdivision on adjacent land uses.
 4. Describe any on-site or off-site land uses creating a nuisance, such as unpleasant odors, unusual noises, dust or smoke.
- D. Historical Features. Provide a letter from the State Historic Preservation Office (SHPO) indicating whether any historic features such as paleontological, archeological or cultural sites, structures, or objects are present on the subject property. If such features are present, provide a written statement outlining any recommendations of SHPO and any plans for inventory, study and/or preservation and mitigation for any adverse impacts.
- E. Visual Impact.
1. Describe any efforts to visually blend development activities with natural surroundings.
 2. If the subdivision is located near the Yellowstone River or the Rimrocks, describe any potential impacts to these natural amenities. Discuss any mitigation efforts to preserve the views.
 3. Provide information regarding revegetation after construction and any proposed landscaping to be provided along streetscapes.

(Ord. No. O17-01, § 16.9.4, 3-7-2017)

16.09.050 Summary of probable impacts.

- A. Describe the effects the proposed subdivision has on the following:
1. Agriculture;
 2. Agricultural water user facilities;
 3. Local services;
 4. The natural environment;
 5. Wildlife and wildlife habitat; and
 6. Public health and safety.

(Ord. No. O17-01, § 16.9.5, 3-7-2017)

Chapter 16.10 DEDICATION OF PARKS, TRAILS, AND OPEN SPACE

16.10.010 Park land dedication requirements (MCA §76-3-621).

- A. Except as provided in Sections 16.10.070 and 16.10.080 herein, a subdivider shall dedicate to the city a cash or land donation equal to:
1. Eleven percent of the area of the net land proposed to be subdivided into parcels of one-half acre or smaller;
 2. Seven and one-half percent of the area of the net land proposed to be subdivided into parcels larger than one-half acre and not larger than one acre;

-
3. Five percent of the area of the net land proposed to be subdivided into parcels larger than one acre and not larger than three acres; and
 4. Two and one-half percent of the area of the net land proposed to be subdivided into parcels larger than three acres and not larger than five acres.
- B. Park dedication requirements for subdivisions that provide for multi-family and condominium developments, and that provide permanent, multiple spaces for recreational camping vehicles or manufactured homes are as follows:
1. Eleven percent of the area of the net land proposed to be developed at a density of one dwelling unit per half acre or less;
 2. Seven and one-half percent of the area of the net land proposed to be developed at a density of between one dwelling unit per half acre and one dwelling unit per one acre;
 3. Five percent of the area of the net land proposed to be developed at a density of between one dwelling unit per one acre and one dwelling unit per three acres; and
 4. Two and one-half percent of the area of the net land proposed to be developed at a density of between one dwelling unit per three acres and one dwelling unit per five acres.
- C. The governing body, in consultation with the subdivider and the planning board, may determine suitable locations for parks and playgrounds and, provided that consideration is given to the preference of the subdivider, may determine whether the park dedication must be a land donation, cash donation, or a combination of both. The combination could include some land dedication to meet the requirement with the cash-in-lieu balance going toward park improvements on the land dedicated. In determining whether land or cash is suitable, proximity to existing parks, including schools and other public or private recreational facilities shall be considered.
- D. A park maintenance district shall be formed or expanded with any new parkland dedication.
- E. The governing body, in consultation with the subdivider, the planning board, provided that consideration is given to the preference of the subdivider, may determine suitable locations for parks and playgrounds. In general parkland should not consist of wet lands, steep slopes, stormwater retention ponds. It should be noted stormwater ponds may be located in parkland, but it cannot contribute to the over all aggregate acreage requirement.

(Ord. No. O17-01, § 16.10.1, 3-7-2017)

16.10.020 School land dedication in lieu of park land dedication (MCA §76-3-621(8)).

Subject to the approval of the governing body and acceptance by the Laurel School Board of Trustees, a subdivider may dedicate land as required by herein to the school district.

(Ord. No. O17-01, § 16.10.2, 3-7-2017)

16.10.030 Linear park land dedication for trail corridors.

To be consistent with Laurel's Bike/Ped Plan Heritage Trail Plan, City and County Growth Management Plan, and the Yellowstone River Greenway Master Plan linear parks for trails may be counted toward the required parkland dedication.

(Ord. No. O17-01, § 16.10.3, 3-7-2017)

16.10.040 Storm water detention/retention ponds in parks.

Storm water detention or retention ponds may be located within public park land, but such areas shall not count toward the park land dedication requirement unless they are designed and constructed to serve as an amenity to the park and fit into the planned uses and improvements to the park. An example of a storm water detention area that is an amenity to a park could be several ponds with water features connecting them designed to have a trail around them with picnic shelters.

(Ord. No. O17-01, § 16.10.4, 3-7-2017)

16.10.050 Determining cash contribution for park land.

Upon submittal of a final plat application, the subdivider shall provide one of the following to verify the fair market value of the land being subdivided that supports the cash contribution for park land the subdivider is providing:

- A. A comparative market analysis performed by a licensed realtor that meets the following criteria:
 - 1. It provides the per acre sale price of at least three comparable parcels of land;
 - 2. The comparable sales must have occurred within one year of the date of the subdivision final plat application submittal; and
 - 3. The comparable sales must be within two miles of the subdivision.
- B. A raw land appraisal by a licensed appraiser.
- C. The sale price of the property being subdivided if it was purchased within one year of the date of the subdivision final plat application submittal.

(Ord. No. O17-01, § 16.10.5, 3-7-2017)

16.10.060 Use of dedicated money or land for parks (MCA §76-3-621(5)).

The appropriate governing body shall use the dedicated money or land for development, acquisition, or maintenance of parks to serve the subdivision and community as follows:

- A. The governing body may use the dedicated money to acquire, develop, or maintain, within its jurisdiction, parks, or recreational areas, or use the money for the purchase of public open space or conservation easements only if:
 - 1. The park, recreational area, open space, or conservation easement is within a reasonably close proximity to the proposed subdivision within the city;
 - 2. the council has formally adopted a park plan that establishes the needs and procedures for use of the money; or
 - 3. Complies with the adopted comprehensive parks plan for the city.
- B. The governing body may not use more than twenty-five percent of the dedicated money for park maintenance.

(Ord. No. O17-01, § 16.10.060, 3-7-2017)

16.10.070 When park land dedication may not be required (MCA §76-3-621(3)).

The following subdivisions may not require parkland dedication:

- A. Land proposed for subdivision into parcels larger than five acres;
- B. Subdivision for parcels that are all nonresidential;
- C. A subdivision in which parcels are not created, except when that subdivision provides permanent multiple spaces for recreational camping vehicles or mobile homes; or
- D. A first minor subdivision from a tract of record as described in MCA § 76-3-609(2).

(Ord. No. O17-01, § 16.10.7, 3-7-2017)

16.10.080 Waiving park land dedication requirement (MCA §76-3-621(6)).

The governing body shall waive the park dedication requirement if:

- A. The subdivision provides for a planned unit development or other development with land permanently set aside for park and recreational uses sufficient to meet the needs of the persons who will ultimately reside in the development; and the area of the land and any improvements set aside for park and recreational purposes equals or exceeds the area of the dedication required under these regulations.
- B. The subdivision provides long-term protection of critical wildlife habitat; cultural, historical, or natural resources; agricultural interests; or aesthetic values; and the area of the land proposed to be subdivided, by virtue of providing long-term protection is reduced by an amount equal to or exceeding the area of the dedication required under Section 16.10.010 of these regulations.
- C. The area of the land proposed to be subdivided, by virtue of a combination of the provisions of Sections 16.10.080(A) and (B) is reduced by an amount equal to or exceeding the area of the dedication required under Section 16.10.010
- D. The subdivider dedicates land outside of the subdivision to be set aside for park and recreational uses sufficient to meet the needs of the persons who will ultimately reside in the subdivision; and the area of the land equals or exceeds the area of the dedication required under Section 16.10.010.

(Ord. No. O17-01, § 16.10.8, 3-7-2017)

Chapter 16.11 ADMINISTRATIVE PROVISIONS.

16.11.010 Variances.

The AGB may grant reasonable variances from only the design and improvement standards of these regulations when strict compliance would result in undue hardship and the result would not negatively affect public health and safety. The granting of a variance shall not have the effect of nullifying the intent and purpose of these regulations. The AGB may not approve a variance that would permit structures within the one hundred-year floodplain, as defined in MCA § 76-5-101.

The planning board shall conduct a public hearing on any variance requested for all subdivisions prior to taking action on the preliminary plat application.

- A. Requesting a Variance. The subdivider shall include with the submission of the preliminary plat a written statement describing the facts of hardship upon which the request for the variance is based.

Each requested variance shall be deemed a separate application, for which a fee shall be required, to be processed concurrently with the preliminary plat. Information addressing each of the following findings shall accompany the application to be approved by the AGB. The latter shall not approve variances unless the subdivider has demonstrated that the request satisfies the following findings:

1. The granting of the variance will not be detrimental to the public health, safety, or general welfare or injurious to other adjoining properties;
 2. Because of the particular physical surroundings, shape, or topographical conditions of the specific property involved, an undue hardship to the owner would result if the strict letter of the regulation was enforced;
 3. The variance will not result in an increase in taxpayer burden;
 4. The variance will not in any manner place the subdivision in nonconformance with any adopted zoning regulations or growth policy; and
 5. The subdivider must prove that the alternative design is equally effective and the objectives of the improvements are satisfied.
- B. In granting variances, the AGB may require conditions of approval that will, in their judgment, secure the objectives of these regulations.
- C. When any such variance is granted, the motion of approval of the proposed subdivision shall contain a statement describing the variance and the facts and conditions upon which the issuance of the variance is based.
- D. An application for a variance is not necessary where planned neighborhood developments are proposed, as modifications to the standards and requirements of these Regulations may be approved by the AGB.

(Ord. No. O17-01, § 16.11.1, 3-7-2017)

16.11.020 Amendments to subdivision regulations.

- A. These regulations may be amended by both governing bodies by their own motion or upon recommendation of the planning board.
- B. Prior to amending these regulations the governing bodies shall conduct a public hearing and public notice shall be given of the intent to amend these regulations and of the public hearing by publication of the time and place of the hearing in a newspaper of general circulation in the city not less than fifteen days prior to the date of the hearing.

(Ord. No. O17-01, § 16.11.2, 3-7-2017)

16.11.030 Corrections or vacations of recorded final plats and supporting documents.

- A. Corrections to recorded final plats shall be processed as exempt plats pursuant to the requirements set forth in Appendix B, provided that there is evidence of at least one of the following:
1. There is a discrepancy in the map;
 2. Material evidence is provided that does not appear on any map filed by the Yellowstone County Clerk and Recorder;
 3. There is evidence that suggests alternate locations of lines or points; or

-
4. The recorded plat does not positively show the location, size of lots or blocks, or the location or width of any street or alley.
- B. Corrections to a recorded subdivision improvements agreement (SIA) or other supporting document of the final plat to which the AGB is party, may be submitted provided that they do not significantly alter the original approval. Requests to alter a recorded SIA or supporting document shall follow these procedures:
1. A written request to amend the recorded document shall be submitted to the planning department.
 2. The request will be circulated for review by the agencies affected by the proposed amendment. The planning department will, in consultation with the affected agencies, submit a recommendation to the AGB.
 3. A public hearing may be required based on the information received by the reviewing agencies. Notice of the public hearing shall be given in accordance with these regulations.
 4. The AGB may approve the request if it does not significantly alter the original approval and does not conflict with the review criteria set forth in these regulations.
- C. Any plat prepared and recorded in accordance with these regulations may be vacated, either in whole or in part.
1. If the vacation affects five or fewer lots it shall be processed as an exempt plat pursuant to the requirements set forth in Appendix B.
 2. If the vacation affects six or more lots it shall be reviewed as an amended plat pursuant to Section 16.11.040 of these regulations.
 3. If the vacation includes public rights-of-way, the applicant must first obtain approval for the right-of-way vacation from the governing body in accordance with the applicable procedures. Title to the streets and alleys of the vacated portions may revert to one or more of the owners of the properties within the platted area adjacent to the vacated portions, as determined by the AGB or designee.
 4. When any utility lines or any other public or private facility are located in a vacated street or alley, at the time of the reversion of the title to the vacated street or alley, the owner of the public or private utility facility shall be granted an easement over the vacated land to continue the operation and maintenance of the public or private utility facility.

(Ord. No. O17-01, § 16.11.3, 3-7-2017)

16.11.040 Corrections or adjustments to plats, conditions and supporting documents after preliminary plat approval.

- A. Minor adjustments may be approved by the planner, in consultation with the appropriate agencies, prior to the filing of the final plat. Minor adjustments are those changes, which, in the opinion of the planner, do not affect the basic character of lots or blocks, do not affect the open space requirement, and do not affect the original street design. Minor adjustments shall not change existing conditions of approval or require additional conditions. Minor adjustments may require that a new plat be drawn; however they do not require that the plat be resubmitted for preliminary plat review.
- B. Major adjustments are those, which, in the opinion of the planner, substantially alter the basic design, or alter open space requirements of the subdivision. Changes to conditions of approval placed on the preliminary plat shall be considered major adjustments unless otherwise determined using the criteria in Section 16.11.040(C), below. Any changes, which constitute a major adjustment, shall require that a new plat be drawn and the plat be re-submitted for preliminary plat review.

-
- C. Requested Amendments to Conditions. Upon written request of the subdivider, the AGB may amend conditions of preliminary plat approval where it can be found that errors or changes beyond the control of the subdivider have rendered a condition unnecessary, impossible or illegal. Requests to amend a condition of approval shall follow these procedures:
1. The request to amend the condition shall be submitted in writing to the planning department.
 2. The request will be circulated for review by the agencies affected by the proposed amendment. The planning department will, in consultation with the affected agencies, submit a recommendation to the AGB.
 3. A public hearing may be required based on the information received by the reviewing agencies. Notice of the public hearing shall be given in accordance with these regulations.
 4. The AGB may approve the request if it can be found that the original condition is unnecessary, impossible or illegal and does not conflict with the review criteria set forth in these regulations.
- D. Once the preliminary plat is approved, unless inaccurate or incomplete information has been found or a change to a condition has been requested, the AGB may not impose any additional conditions as a prerequisite to final plat approval, providing that approval is obtained within the original or extended approval period as provided in these regulations.

(Ord. No. O17-01, § 16.11.4, 3-7-2017)

16.11.050 Appeals.

- A. A person who has filed with the AGB an application for a subdivision under these regulations may bring an action in district court to sue the AGB to recover actual damages caused by a final action, decision, or order of the AGB or these Regulations that is arbitrary or capricious.
- B. A party who is aggrieved by a decision of the AGB to approve, conditionally approve, or disapprove a proposed preliminary plat or final subdivision plat may, within thirty days after the decision, appeal to the district court. The petition must specify the grounds upon which the appeal is made.
- C. The following parties may appeal under the provisions of Section 16.11.050(B):
1. The subdivider;
 2. A landowner with a property boundary contiguous to the proposed subdivision or a landowner with property within the city/county where the subdivision is proposed if that landowner can show a likelihood of material injury to the landowner's property or its value; or
 3. The Yellowstone County Board of County Commissioners.
- D. For the purposes of this section, "aggrieved" means a person who can demonstrate a specific personal and legal interest, as distinguished from a general interest, who has been or is likely to be specially and injuriously affected by the decision.

(Ord. No. O17-01, § 16.11.5, 3-7-2017)

16.11.060 Schedule of fees.

The required fee shall accompany the preliminary plat, final plat, exempt surveys, and any proposed variances. A schedule of fees for plats shall be established by the city council by resolution.

(Ord. No. O17-01, § 16.11.6, 3-7-2017)

16.11.070 Penalty for violation.

- A. Except as provided in MCA § 76-3-303, every final subdivision plat shall be filed with the county clerk and recorder before title to the subdivided land can be sold or transferred in any manner. If illegal transfers are completed, an attorney for the city shall commence action to enjoin further sales or transfers and compel compliance with the provisions of the Montana Subdivision and Platting Act (MCA §76-3-101 et seq.) and these regulations. The cost of such action shall be imposed against the person transferring the property.

Each sale, lease or transfer, or offer of sale, lease, or transfer of each separate parcel of land in violation of any provision of the Montana Subdivision and Platting Act or these Regulations shall be deemed a separate and distinct offense.

- B. Any person who violates any of the provisions of the Montana Subdivision and Platting Act (MCA § 76-3-101 et seq.) or these regulations is guilty of a misdemeanor and punishable by a fine of not less than one hundred dollars nor more than five hundred dollars or by imprisonment in jail for not more than three months or by both fine and imprisonment.

(Ord. No. O17-01, § 16.11.6, 3-7-2017)

APPENDIX A

Jurisdictional Area Map

Title 16 - SUBDIVISIONS
APPENDIX B

1. Any person seeking exemption from MSPA shall submit to the Planner (1) a certificate of survey, exempt amended plat, or where a survey is not required an instrument of conveyance, and (2) evidence of, and a notarized statement affirming, entitlement to the claimed exemption signed by the landowner.
2. When a certificate of survey, exempt amended plat, or instrument of conveyance is submitted to the Planner, the latter shall examine the proposed land division to determine whether it complies with the requirements of this Appendix, the MSPA, and the Montana Sanitation in Subdivisions Act (MCA §76-4-101, et seq.).
3. If the Planner finds that the proposed use of the exemption complies with the statutes and these criteria, the Planner shall recommend to the Clerk and Recorder the document be filed. If the Planner finds that the proposed use of the exemption is not in compliance, the Planner shall return the materials to the landowner with an explanation as to why the recordation was declined.
4. Any person whose proposed use of an exemption has been denied by the designated agents may appeal the agents' decision to the AGB.
5. Exempt divisions of land that would result in a pattern of development equivalent to a subdivision shall be presumed to be adopted for purposes of evading the Act. A "pattern of development" occurs whenever three or more parcels of less than 160 acres each with common covenants or facilities pertaining to each parcel have been divided from the original tract.
6. If the use of an exemption is determined to be an evasion of MSPA, the landowner may submit a subdivision application for the proposed land division.

B. Exemption as a Gift or Sale to a Member of the Immediate Family (MCA §76-3-207(1)(b)).

1. Statement of Intent: The intention of this exemption is to allow a landowner to convey one parcel to each member of the immediate family without local subdivision review. A single parcel may be conveyed to each member of the immediate family under this exemption in each county where the landowner owns property.
2. "Immediate family" is defined as the spouse, children by blood or adoption, or parents of the grantor (MCA §76-3-103(7)).
3. Any certificate of survey filed that would use this exemption to create a parcel for conveyance to a family member must clearly identify the name of the grantee, the grantee's relationship to the landowner, and the parcel to be conveyed under this exemption, and be accompanied by, or contain, the landowner's written certification of compliance. The certificate of survey or other instrument must also cite the exemption claimed and include language similar to that provided in Section H of this Appendix. Also, the certificate of survey or instrument of conveyance shall be accompanied by a deed or other conveying document.
4. One conveyance of a parcel to each member of the landowner's immediate family is eligible for exemption from subdivision review. However, the use of the exemption may not result in more than one remaining parcel of less than 160 acres.
5. Any proposed use of the family conveyance exemption to divide a tract that was previously created through use of an exemption shall be presumed to be an evasion of the Act if it creates a pattern of development consistent with an overall plan with characteristics such as common roads, utility easements, restrictive covenants, open space, or common marketing. This presumption will not be rebutted by previous ownership of the tracts, and pertains to remaining tracts of less than 160 acres as well as to those tracts that were previously created through the use of one or more of the exemptions.

6. The use of the family conveyance exemption to divide tracts that were created as part of an overall development plan with characteristics such as common roads, utility easements, restrictive covenants, open space or a common marketing or promotional plan shall be presumed that the use of the exemption is an evasion the Act.

C. Exemption to Provide Security for a Construction Mortgage, Lien, or Trust Indenture (MCA §76-3-201(1)(b)).

1. Statement of Intent: Under policies of many lending institutions and federal home loan guaranty programs, a landowner who is buying a tract with financing or through a contract for deed is required to hold title to the specific site on which the residence will be built. The intended purpose of this exemption is to allow a landowner who is buying a tract using financing or a contract for deed to segregate a smaller parcel from the tract for security for financing construction of a home on the property.
2. When claiming this exemption, the landowner shall submit the following documents to the City-County Planning Department:
 - a. A signed statement from both the landowner and the lending institution that the creation of the exempted parcel is necessary for the owner to secure construction financing through a construction mortgage, lien or trust indenture on the exempted parcel.
 - b. Any certificate of survey that uses this exemption must bear the acknowledged certificate of the property owner stating that the division of land in question is exempted from review as a subdivision, cite the exemption claimed, and include the language provided in Section H of this Chapter.
3. The use of this exemption is presumed to have been adopted for the purpose of evading MSPA if:
 - a. It will create a site for more than one dwelling unit;
 - b. The loan is for someone other than the owner of record or the recorded contract purchaser of the parcel to be divided.
 - c. It will create a pattern of development, which is equivalent to a subdivision with characteristics such as common roads, sewer, water, utility easements, restrictive covenants, open space or a common marketing or promotional plan.

D. Exemption for Agricultural Purposes (MCA §76-3-207(1)(c)).

1. Statement of Intent: The intention of this exemption is to allow a landowner to create a parcel without local review where the parcel will be used only for production of livestock or agricultural crops and where no residential, commercial, or industrial buildings will be built.
2. "Agricultural Purpose," for purposes of these evasion criteria, means the use of land for raising crops or livestock, or for the preservation of open space, and specifically excludes residential structures and facilities for commercially processing agricultural products. Agricultural lands are exempt from review by the Montana Department of Environmental Quality (MDEQ), provided the applicable exemption is properly invoked by the property owner.
3. The following conditions must be met or the use of the exemption will be presumed to have been adopted for the purposes of evading MSPA:
 - a. The parties to the transaction by gift, sale, or agreement, must enter into a covenant running with the land and revocable only by mutual consent of the governing body and the property owner that the divided land will be used exclusively for agricultural purposes or open space. The

covenant must be signed by the property owner, the buyer or lessee and the governing body. An example of a covenant is provided in Section H of this Chapter.

- b. The landowner must demonstrate that the planned use of the exempted parcel is for agricultural purposes and that no residential, commercial or industrial buildings will be built (e.g., a statement signed by the buyer).
- c. Any change in use of the land for anything other than agricultural purposes subjects the parcel to full review as a subdivision.
- d. Residential, commercial and industrial structures, including facilities for commercial processing of agricultural products are excluded uses on parcels created under this exemption unless the covenant is revoked and the land division is reviewed under Title 76, Chapter 3, Mont. Code Ann.
- e. A certificate of survey that uses this exemption must bear the acknowledged certificate of the property owner stating that the division of land in question is exempted from review as a subdivision, cite the exemption claimed, and include language similar to that provided in Section H of this Appendix.

E. Relocation of Common Boundary (MCA §76-3-207(1)(a)(d) and (e)).

1. Statement of Intent: The intended purpose of this exemption is to allow a change in the location of a boundary line between two parcels and to allow a one-time transfer of a tract to effect that change in location without subdivision review.
2. If the relocation of a common boundary would result in the permanent creation of an additional parcel of land, the division of land must be reviewed as a subdivision. If a temporary tract is created, language shall be added to indicate that the temporary tract is merged forever with the adjacent tract.
3. Within a platted subdivision, a division of lots that redesigns or rearranges six or more lots must be reviewed and approved by the AGB and an amended plat and must be filed with the County Clerk and Recorder in accordance with Section 16.12.020 of these Regulations.
4. Certificates of survey or amended plats claiming this exemption must be clearly distinguished between the existing boundary location and the new boundary. This shall be accomplished by representing the existing boundary with a dashed line and the new boundary with a solid line. The appropriate certification must be included on the certificate of survey as provided in Section H of this Appendix.

F. Remainder Parcels.

Statement of Intent: Any part of an original tract of record, less than 160 acres that is left following the segregation of other parcels from the tract for the purpose of transfer shall be reviewed as part of the subdivision.

G. Certification.

1. **Exemption Certificates.** The following represents examples of certificates to be used on certificates of surveys for the following types of exemptions: relocation of common boundaries, land gift or sale to family member, agricultural exemption, and security for constructions.

CERTIFICATE OF EXEMPTION

(FAMILY GIFT OR SALE)

I (We) certify that the purpose of this survey is to create Tract # ____ for transfer of ownership as a family gift or sale and that no prior family sale has been conveyed to (name), our (my) (relationship) _____ and that this exemption complies with all conditions imposed on its use. Therefore this survey is exempt from review as a subdivision pursuant to Section MCA §76-3-207(1)(b).

Title 16 - SUBDIVISIONS
APPENDIX B

DATED THIS _____ day of _____, 200__.

(Signature)

Property Owner(s)

**CERTIFICATE OF EXEMPTION
(RELOCATION OF COMMON BOUNDARY)**

I (We) certify that the purpose of this survey is to relocate common boundaries between adjoining properties existing outside of a platted subdivision. Therefore this survey is exempt from review as subdivision pursuant to Section MCA §76-3-207(1)(a)(d) or (e).

DATED THIS _____ day of _____, 200__.

(Signature)

Property Owner(s)

**CERTIFICATE OF EXEMPTION
(FOR AGRICULTURAL PURPOSES)**

I (We) certify that the purpose of this survey is to create Tract # _____, as shown on this certificate of survey, for gift or sale, which is to be used for agricultural purposes only, and that this exemption complies with all conditions imposed on its use. Therefore, this survey is exempt from review as a subdivision pursuant to Section MCA § 76-3-207(1)(c). I also hereby enter a covenant, to run with the land, that Tract _____ as shown hereon, will be used exclusively for agricultural purposes only. No building or structure requiring water or sewer facilities shall be utilized on Tract _____. This covenant is revocable only by the mutual consent of the governing body and the property owner.

DATED THIS _____ day of _____, 200__.

(Signature)

Property Owner(s)

**CERTIFICATE OF EXEMPTION
(SECURITY FOR CONSTRUCTION)**

I certify that the purpose of this survey is to create a parcel of land to provide security for construction or loan purposes and that this exemption complies with all conditions imposed on its use. Therefore, this survey is exempt from review as a subdivision pursuant to Section MCA §76-3-201(1)(b) and from review by the Montana Department of Environmental Quality (16.16.605(1)(b)).

DATED THIS _____ day of _____, 200__.

(Signature)

Property Owner(s)

(Ord. 07-01 (part), 2007)

APPENDIX C

Pre-Application Meeting Form*

Title 16 - SUBDIVISIONS
APPENDIX C

Application Date:

Name of Owner: _____ Phone:

Address:

Name of subdivision (if known):

Surveyor/Engineer: Phone:

Address:

Parcel Description

Legal Description:

General Location:

Parcel Size:

Number of Lots:

Existing Zoning:

Proposed Zoning:

Existing and Proposed Use:

* This application shall be accompanied by 6 conceptual drawings at least one (1) week in advance of the pre-application meeting.

City of Laurel Received stamp:

PO Box 10 (City)

Laurel, Mt. 59044

406-628-4796

(Ord. 07-01 (part), 2007)

APPENDIX D

Preliminary Plat Requirements

The following information is required for all preliminary plat submittals:

Submittal Copies:

___ 24"x36" plat and supplements (number of copies specified by staff)

___ 11"x17" plat and supplements (number of copies specified by staff)

 1 Electronic copy of plat (in AutoCad® or ArcInfo® format) and supplements (a high quality scanned copy in .jpg or .pdf may suffice if other formats are unavailable)

 1 Electronic copy of plat (in .jpg or .pdf format)

Plat Contents:

Title 16 - SUBDIVISIONS
APPENDIX D

1. Subdivision name that does not duplicate an existing subdivision name
2. Legal description including quarter section, Township and Range
3. Owner, subdivider (if different from owner), engineer and surveyor
4. Date plat was prepared
5. North arrow and scale bar
6. Vicinity map of sufficient detail to locate the subdivision
7. Names and addresses of adjoining property owners
8. Names of adjoining subdivisions and certificates of survey
9. Location of all existing physical features on land adjacent to and within subdivision, including but not limited to:
 - Structures
 - Utilities
 - Irrigation facilities
 - Rock outcrops
 - Areas of 25% slope or greater
10. Locations and dimensions of:
 - Proposed streets and street names that do not duplicate existing street names
 - Sidewalks and/or pathways, trails
 - Alleys, internal private streets, driveways
 - Easements
 - Parkland
 - Street centerline curve radii
11. Proposed layout of:
 - Water distribution system
 - Sanitary sewer system
 - Storm drainage facilities
 - Location of nearest available utilities
12. Lot lines, lot numbers, lot areas and block numbers
13. Site data including:
 - Number of lots
 - Maximum lot area
 - Minimum lot area
 - Area of parkland
 - Linear feet of streets

Title 16 - SUBDIVISIONS
APPENDIX D

- Net and gross acreage of land to be subdivided
 - Existing and proposed zoning
 - Existing and proposed land use
14. Tentative finished grades of each street indicated by spot elevations
 15. Location of streams, lakes, wetlands, floodplain boundaries, and land subject to flooding
 16. In case of a subsequent subdivision, the subdivision superimposed on a copy of the existing plat
 17. All plats shall be neatly drawn in a professional manner
 18. All plats to be filed as an Addition to the City shall be noted in title
 19. Contour lines of not more than five foot intervals; where lots are proposed on slopes 10% or less, contours must be shown at two-foot intervals
 20. Approximate location of all sections lines and corners pertinent to the proposed subdivision.
- (Ord. 07-01 (part), 2007)

APPENDIX E

Preliminary Plat Application

Subdivision Name:

Date of Preapplication Meeting:

Type: Major _____ First Minor _____ Subsequent Minor _____

Tax Code:

Location:

Legal Description:

¼ Section: _____, **Township:** _____, **Range:** _____

General Location:

Subdivider Information:

Name (Include a list of officers if corporation):

Address:

Telephone: _____ E-mail:

Owner Information:

Name:

Address:

Telephone: _____ Email:

Title 16 - SUBDIVISIONS
APPENDIX E

Plat Data:

Gross Area:

Net Area:

Number of Lots:

Maximum Lot Size:

Minimum Lot Size:

Linear Feet of Streets:

Existing Zoning:

Surrounding Zoning:

North:

South:

East:

West:

Existing Land Use:

Proposed Land Use:

Parkland Requirement:

Land: _____ Acres: _____

Cash: _____ Cash: \$ _____

Variances Requested (list and attach Variance Request):

- 1.
- 2.
- 3.

Service Providers for Proposed Subdivision

Gas:

Electric:

Telephone:

School (Elementary, Middle, High):

Irrigation District:

Cable Television:

List of Materials Submitted with Application

- 1.
- 2.
- 3.

- 4.
- 5.
- 6.

Agent Information

Name:

Address:

Telephone:

I declare that I am the owner of record of the above-described property, and have examined all statements and information contained herein, and all attached exhibits, and to the best of my knowledge and belief, is true and correct.

Owner of Record Date

Owner Under Contract Date

The submission of a preliminary plat application constitutes a grant of permission by the subdivider to enter the subject property.

(Ord. 07-01 (part), 2007)

APPENDIX F

Required Supporting Documents for Major Preliminary Plat Applications

1. Names and addresses of immediately adjoining property owners typed or neatly printed on address labels.
2. Draft Subdivision Improvements Agreement (Appendix L).
3. Environmental Assessment or Summary of Probable Impacts, when applicable (Article 23-900).
4. Traffic Accessibility Study (TAS) when applicable, containing the following information:
 - a. Trip generation, using the Institute of Transportation Engineers Trip Generation Manual;
 - b. Trip distribution;
 - c. Traffic assignment;
 - d. Capacity analysis;
 - e. Evaluation; and
 - f. Recommended access plan, including access points, modifications, and any mitigation techniques.
 - g. Land use and trip generation in the form of a table of each type of land use, the number of units or square footage, as appropriate, the trip rates used (daily and peak) and resulting trip generation.
 - h. Traffic graphics, which show:
 - AM peak hour site traffic;

Title 16 - SUBDIVISIONS
APPENDIX F

- PM peak hour site traffic;
 - AM peak hour total traffic;
 - PM peak hour total traffic;
 - Total daily traffic (with site generated traffic shown separately).
- i. AM and PM capacity analysis with an AM and PM peak hour capacity analysis provided for:
- All major drive accesses that intersect collector or arterial streets or roads; and
 - All arterial-arterial, collector-collector and arterial-collector intersections within one mile of the site, or as required by the Director of Public Service during the pre-application review.
- j. Capacity. Indicate the levels of service (before and after development) of existing and proposed streets and roads, including appropriate intersections, to safely handle any increased traffic. Describe any anticipated increased maintenance that will be necessary due to increased traffic and who will pay the cost of maintenance.
- k. Bicycle and Pedestrian Pathways, Lanes and Routes. Describe bicycle and pedestrian pathways, lanes or routes to be developed with the development.
- l. Traffic Calming. Detailed drawings of any proposed traffic calming installations, including locations and turning radius templates.
5. Preliminary water and sanitation information, including:
- a. A site plan or exhibit that shows:
- The location, within 100 feet outside of the exterior property line of subdivision and on the proposed lots, of:
 - Floodplains
 - Surface water features
 - Springs
 - Irrigation ditches
 - Existing, previously approved, and, for parcels less than 20 acres, proposed water wells and wastewater treatment systems;
 - For parcels less than 20 acres, mixing zones identified, and
 - The representative drain field site used for the soil profile description, and
 - The location, within 500 feet outside of the exterior property line of the subdivision, of public water and sewer facilities.
- b. A description of the proposed subdivision's water supply systems, storm water systems, solid waste disposal systems, and wastewater treatment systems, including whether the water supply and wastewater treatment systems are individual, shared, multiple user, or public as those systems are defined in rules published by the Montana Department of Environmental Quality (MDEQ).
- c. A drawing of the conceptual lot layout at a scale no smaller than 1 inch equal to 200 feet that shows all information required for a lot layout document in rules adopted by MDEQ pursuant to MCA §76-4-104.
- d. Evidence of suitability for new onsite wastewater treatment systems that, at a minimum, includes:
- A soil profile description from a representative drain field site identified on the vicinity map, as provided above, that complies with standards published by the MDEQ,

Title 16 - SUBDIVISIONS
APPENDIX F

- Demonstration that the soil profile contains a minimum of 4 feet of vertical separation distance between the bottom of the permeable surface of the proposed wastewater treatment system and a limiting layer, and
 - In cases in which the soil profile or other information indicates that groundwater is within 7 feet of the natural ground surface, evidence that the groundwater will not exceed the minimum vertical separation distance.
 - e. For new water supply systems, unless cisterns are proposed, evidence of adequate water availability;
 - Obtained from well logs or testing of onsite or nearby wells;
 - Obtained from information contained in published hydro-geological reports; or
 - As otherwise specified by rules adopted by the MDEQ pursuant to MCA §76-4-104.
 - f. A preliminary analysis of potential impacts to the groundwater quality from new wastewater treatment systems, using as guidance rules adopted by the Board of Environmental Review pursuant to MCA §75-5-301 and MCA §75-5-303 related to standard mixing zones for groundwater, source specific mixing zones, and nonsignificant changes in water quality. The preliminary analysis may be based on currently available information and must consider the effects of overlapping mixing zones from proposed and existing wastewater treatment systems within and directly adjacent to the subdivision. Instead of performing the preliminary analysis required under this subsection, the subdivider may perform a complete nondegradation analysis in the same manner as is required for an application that is reviewed under Title 76, Chapter 4, Mont. Code Ann.
 - g. A subdivider whose land division is excluded from review under MCA §76-4-125(2) is not required to submit the water and sanitation information listed above.
 - 6. Geotechnical Report that includes:
 - a. A summary of hazards present and recommended actions.
 - b. A description of proposed construction.
 - c. A description of the investigation methods, including field investigations, laboratory analysis and report preparation.
 - d. A description of the site conditions, including soil, bedrock, groundwater and other physical features present that may limit development.
 - e. Analysis of engineering properties and recommendations in relation to foundations; over-excavation and engineered fill; bearing capacity; lateral loads on basement walls; soil friction factor; earthwork; site grading and runoff control; foundation and retaining wall drainages; slabs on grade; reinforcing, utilities testing and concrete considerations; and ventilation and radon.
 - f. Summary of engineering limitations.
 - g. The report shall be accompanied by figures and tables sufficient to convey the results of each test hole and an overall site plan showing the location of each test hole. The spacing of test holes will be dependent of the horizontal and vertical variation of the subsurface material. In all cases, the spacing should result in a representation of all soils present on the subdivision.
 - 7. Draft protective and restrictive covenants, if any.
 - 8. Draft Articles of Incorporation when Homeowner's Association is proposed.
 - 9. When a tract of land is to be subdivided in separate filings, a Master Plan of the entire area to be developed.
- (Ord. 07-01 (part), 2007)

APPENDIX G

Required Supporting Documents for First Minor Preliminary Plat Applications

1. Draft Subdivision Improvements Agreement.
2. Traffic Accessibility Study (TAS) when applicable, containing the following information:
 - a. Trip generation, using the Institute of Transportation Engineers Trip Generation Manual;
 - b. Trip distribution;
 - c. Traffic assignment;
 - d. Capacity analysis;
 - e. Evaluation; and
 - f. Recommended access plan, including access points, modifications and any mitigation techniques.
 - g. Land use and trip generation in the form of a table of each type of land use, the number of units or square footage, as appropriate, the trip rates used (daily and peak) and resulting trip generation.
 - h. Traffic graphics, which show:
 - AM peak hour site traffic;
 - PM peak hour site traffic;
 - AM peak hour total traffic;
 - PM peak hour total traffic;
 - Total daily traffic (with site generated traffic shown separately).
 - i. AM and PM capacity analysis with an AM and PM peak hour capacity analysis provided for:
 - All major drive accesses that intersect collector or arterial streets or roads; and
 - All arterial-arterial, collector-collector and arterial-collector intersections within one mile of the site, or as required by the Director of Public Service during the pre-application review.
 - j. Capacity. Indicate the levels of service (before and after development) of existing and proposed streets and roads, including appropriate intersections, to safely handle any increased traffic. Describe any anticipated increased maintenance that will be necessary due to increased traffic and who will pay the cost of maintenance.
 - k. Bicycle and Pedestrian Pathways, Lanes and Routes. Describe bicycle and pedestrian pathways, lanes or routes to be developed with the development.
 - l. Traffic Calming. Detailed drawings of any proposed traffic calming installations, including locations and turning radius templates.
3. Preliminary water and sanitation information, including:
 - a. A site plan or exhibit that shows:
 - The location, within 100 feet outside of the exterior property line of subdivision and on the proposed lots, of:
 - Floodplains
 - Surface water features

Title 16 - SUBDIVISIONS
APPENDIX G

- Springs
 - Irrigation ditches
 - Existing, previously approved, and, for parcels less than 20 acres, proposed water wells and wastewater treatment systems;
 - For parcels less than 20 acres, mixing zones identified, and
 - The representative drain field site used for the soil profile description, and
 - The location, within 500 feet outside of the exterior property line of the subdivision, of public water and sewer facilities.
 - b. A description of the proposed subdivision's water supply systems, stormwater systems, solid waste disposal systems, and wastewater treatment systems, including whether the water supply and wastewater treatment systems are individual, shared, multiple user, or public as those systems are defined in rules published by the Montana Department of Environmental Quality (MDEQ).
 - c. A drawing of the conceptual lot layout at a scale no smaller than 1 inch equal to 200 feet that shows all information required for a lot layout document in rules adopted by MDEQ pursuant to MCA §76-4-104.
 - d. Evidence of suitability for new onsite wastewater treatment systems that, at a minimum, includes:
 - A soil profile description from a representative drain field site identified on the vicinity map, as provided above, that complies with standards published by the MDEQ,
 - Demonstration that the soil profile contains a minimum of 4 feet of vertical separation distance between the bottom of the permeable surface of the proposed wastewater treatment system and a limiting layer, and
 - In cases in which the soil profile or other information indicates that groundwater is within 7 feet of the natural ground surface, evidence that the groundwater will not exceed the minimum vertical separation distance.
 - e. For new water supply systems, unless cisterns are proposed, evidence of adequate water availability;
 - Obtained from well logs or testing of onsite or nearby wells;
 - Obtained from information contained in published hydro-geological reports; or
 - As otherwise specified by rules adopted by the MDEQ pursuant to MCA §76-4-104.
 - f. A preliminary analysis of potential impacts to the groundwater quality from new wastewater treatment systems, using as guidance rules adopted by the Board of Environmental Review pursuant to MCA §75-5-301 and MCA §75-5-303 related to standard mixing zones for groundwater, source specific mixing zones, and nonsignificant changes in water quality. The preliminary analysis may be based on currently available information and must consider the effects of overlapping mixing zones from proposed and existing wastewater treatment systems within and directly adjacent to the subdivision. Instead of performing the preliminary analysis required under this subsection, the subdivider may perform a complete nondegradation analysis in the same manner as is required for an application that is reviewed under Title 76, Chapter 4, Mont. Code. Ann.
 - g. A subdivider whose land division is excluded from review under MCA §76-4-125(2) is not required to submit the water and sanitation information listed above.
4. Geotechnical Report that includes:
- a. A summary of hazards present and recommended actions.
 - b. A description of proposed construction.

Title 16 - SUBDIVISIONS
APPENDIX G

- c. A description of the investigation methods, including field investigations, laboratory analysis and report preparation.
 - d. A description of the site conditions, including soil, bedrock, groundwater and other physical features present that may limit development.
 - e. Analysis of engineering properties and recommendations in relation to foundations; over-excavation and engineered fill; bearing capacity; lateral loads on basement walls; soil friction factor; earthwork; site grading and runoff control; foundation and retaining wall drainages; slabs on grade; reinforcing, utilities testing and concrete considerations; and ventilation and radon.
 - f. Summary of engineering limitations.
 - g. The report shall be accompanied by figures and tables sufficient to convey the results of each test hole and an overall site plan showing the location of each test hole. The spacing of test holes will be dependent of the horizontal and vertical variation of the subsurface material. In all cases, the spacing should result in a representation of all soils present on the subdivision.
- 5. Draft protective and restrictive covenants, if any.
 - 6. Draft Articles of Incorporation when Homeowner's Association is proposed.
 - 7. When a tract of land is to be subdivided in separate filings, a Master Plan of the entire area to be developed.
- (Ord. 07-01 (part), 2007)

APPENDIX H

Expedited Final Plat Application

- 1. **Name of subdivision**
- 2. **Tax ID #**
- 3. **Location**
 - a. Legal Description: 1/4 Section, Township, and Range:
 - b. General location:
- 4. **Name, Address & Telephone Number of Subdivider**
 - a. Name:
 - b. Address:
 - c. Telephone:
- 5. **Name, Address & Telephone Number of Owner**
 - a. Name:
 - b. Address:
 - c. Telephone:

Title 16 - SUBDIVISIONS
APPENDIX H

6. **Plat Data: Gross Area:** _____ **Net Area:** _____

No. of Lots:

7. **List of materials submitted with final application**

Required:

- a. Final Plat
- b. Subdivision Improvements Agreement and Waiver
- c. Title Report
- d. Red lined check print

Other:

8. **Deed restrictions or covenants? Yes** _____ **No** _____; if yes, please attach copies.

9. **Name, address & telephone of professional consultant(s)**

Surveyor/engineer:

Address:

Attorney:

Address:

Other:

Address:

I declare that I am the owner of record and that all the statements and information contained in all exhibits transmitted herewith are true and correct. I hereby apply for approval of the final plat of:

Owner/Owners:

(Signature of Owner/Owners)

Owners under Contract:

(Signature of Owners under contract)

(Ord. 07-01 (part), 2007)

APPENDIX I

Final Plat Application

1. Name of Subdivision

2. Tax ID #

3. Location

- a. Legal Description: 1/4 Section, Township, and Range:
- b. General location:

4. Name, Address & Telephone Number of Subdivider

Name:

- b. Address:
- c. Telephone:

5. Name, Address & Telephone Number of Owner

- a. Name:
- b. Address:
- c. Telephone:

6. Plat Data

- a. Gross area:
- b. Net area:
- c. Number of lots:

7. Park Requirement

- a. Land:
- b. Cash: \$

8. Date preliminary plat approved:

9. List of materials submitted with final application

Required:

- a. Final Plat
- b. Subdivision Improvements Agreement
- c. Conditions of Approval
- d. Title Report
- e. Red lined check print

Other:

10. Deed restrictions or covenants? Yes _____ No _____; if yes, please attach copies.

11. Name, address & telephone of professional consultant(s)

Surveyor/engineer:

Address:

Attorney:

Address:

Other:

Address:

I declare that I am the owner of record and that all the statements and information contained in all exhibits transmitted herewith are true and correct. I hereby apply for approval of the final plat of:

Owner/Owners:

(Signature of Owner/Owners)

Owners under Contract:

(Signature of Owners under contract)

(Ord. 07-01 (part), 2007)

APPENDIX J

Final Plat Requirements

1. A final subdivision plat may not be approved by the governing body or filed by the County Clerk and Recorder unless it complies with the following requirements:
 - a. Final subdivision plats must be legibly drawn with permanent ink or printed or reproduced by a process guaranteeing a permanent record and must be 18 inches by 24 inches or 24 inches by 36 inches overall to include a 1 ½-inch margin on the binding side.
 - b. Two signed copies on three mil. or heavier matte stable-base polyester film or equivalent must be submitted.
 - c. If more than one sheet must be used to adequately depict the land subdivided, each sheet must show the number of that sheet and the total number of sheets included. All certifications must be placed or referred to on one sheet.
 - d. A survey that modifies a filed subdivision plat must be entitled "amended plat of (lot, block and name of subdivision being amended)," and unless it is exempt from subdivision review by MCA §76-3-201 or MCA §76-3-207(1)(d) or (e), may not be filed with the County Clerk and Recorder unless it meets the filing requirements for final subdivision plats specified in these requirements.
2. A final plat submitted for approval must show or contain, on its face the following information. The surveyor may, at his or her discretion, provide additional information regarding the survey.
 - a. A title or title block indicating the quarter section, section, township, range, principal meridian, county and, if applicable city or town, in which the subdivision is located. The title of the plat must contain the words "plat" and either "subdivision" or "addition".
 - b. The name of the person(s) who commissioned the survey and the name(s) of the owner of the land to be subdivided if other than the person(s) commissioning the survey, the names of any adjoining platted subdivisions, and the numbers of any adjoining certificates of survey previously filed.
 - c. Vicinity sketch of sufficient area to identify the location of the subdivision.
 - d. A north arrow.
 - e. A scale bar. The scale must be sufficient to legibly represent the required information and data on the plat.
 - f. The location of, and other information relating to all monuments found, set, reset, replaced or removed as required by ARM 8.94.3001(1)(c).

Title 16 - SUBDIVISIONS
APPENDIX J

- i. If additional monuments are to be set after the plat is filed, the location of these monuments must be shown by a distinct symbol, and the plat must bear a certification by the surveyor as to the reason the monuments have not been set and the date by which they will be set.
- ii. All monuments found during a retracement that influenced the position of any corner or boundary indicated on the plat must be clearly shown as required by ARM 8.94.3001(1)(c).
- g. The location of any section corners or corners of divisions of sections pertinent to the survey.
- h. Witness and reference monuments and basis of bearings. For purposes of these the term "basis of bearings" means the surveyor's statement as to the origin of the bearings shown on the plat. The basis of bearings may refer to a particular line between monumented points in a previously filed survey document. If the plat shows true bearings, the basis of bearings must describe the method by which these true bearings were determined.
- i. The bearings, distances and curve data of all boundary lines. If the subdivision is bounded by an irregular shoreline or body of water that is a riparian boundary, the bearings and distances of a meander traverse generally paralleling the riparian boundary must be given.
- i. The courses along a meander line are shown solely to provide a basis for calculating the acreage of a parcel with one or more riparian boundaries as the parcel existed at the time of survey.
- ii. For purposes of these regulations a line that indicates a fixed boundary of a parcel is not a "meander" or "meander line" and may not be designated as one.
- j. Data on all curves sufficient to enable the re-establishment of the curves on the ground. For circular curves these data must at least include radius and arc length. For non-tangent curves, which must be so labeled, the plat must include the bearings of radial lines or chord length and bearing.
- k. Lengths of all lines shown to at least tenths of a foot, and all angles and bearings shown to at least the nearest minute. Distance measurements must be stated in English units, but their metric equivalents, shown to the nearest hundredth of a meter, may be noted parenthetically.
- l. All lots and blocks in the subdivision, designated by number, the dimensions of each lot and block, the area of each lot, and the total acreage of all lots. (Excepted parcels must be marked "Not included in this subdivision" or "Not included in this plat," as appropriate, and the bearings and lengths of these excepted boundaries must be shown.)
- m. All streets, alleys, avenues, roads and highways; their widths (if ascertainable) from public records, bearings and area; the width and purpose of all road rights-of-way and all other easements that will be created by the filing of the plat; and the names of all streets, roads and highways.
- n. The location, dimensions and areas of all parks, common areas and other grounds dedicated for public use.
- o. The total acreage of the subdivision.
- p. A narrative legal description of the subdivision as follows:
 - (i) If the parcel being subdivided is either an aliquot part of a U.S. government section or a U.S. government lot, the information required by this subsection is the aliquot or government lot description of the parcel.
 - (ii) If the plat depicts the division of a parcel or lot that is shown on a filed certificate of survey or subdivision plat, the information required by this subsection is the number or name of the certificate of survey or plat and the number of the parcel or lot affected by the survey.
 - (iii) If the parcel surveyed does not fall within (2)(p)(i) or (ii), above, the information required by this subsection is the metes-and-bounds description of the perimeter boundary of the subdivision.

Title 16 - SUBDIVISIONS
APPENDIX J

(iv) If the plat establishes the boundaries of a subdivision containing one or more interior parcels, the information required by this subsection is the legal description of the perimeter boundary of the subdivision.

q. **Certificate of Surveyor.** The dated signature and the seal of the surveyor responsible for the survey and a memorandum of any oaths administered under MCA §76-3-405. The affixing of this seal constitutes a certification by the surveyor that the final plat has been prepared in conformance with the Montana Subdivision and Platting Act (MCA §76-3-101 through MCA §76-3-625) and the regulations adopted under that Act.

r. **Certificate of Dedication.** The dated, signed and acknowledged consent to the subdivision of the owner of the land being subdivided. For purposes of this rule when the parcel of land proposed for subdivision is being conveyed under a contract-for-deed, the terms "owner" and "owner of the land" refers to the seller under the contract-for-deed.

s. **If applicable, Consent to Platting.**

t. **Certificate of Approval.** Certification by the governing body that the final subdivision plat is approved.

u. **Notice of Approval.** Statement that the final plat is approved by the Yellowstone County Board of Planning.

v. **Certificate of City Engineer's Office.** If applicable, Certification by the City Engineer that municipal water, sewage disposal and solid waste disposal will be provided. (City only)

w. **Errors and Omissions Review.** Certification of the reviewing surveyor that the survey has been examined and approved.

x. **Certificate of City Attorney.** Certification that the plat has been reviewed and accepted by the City Attorney.

y. **Certificate of County Treasurer.** Certification of county treasurer showing current tax payment.

z. If applicable, the owner's certificate of dedication of streets, parks, playground easements or other public improvements.

aa. Space for the clerk and recorder's filing information.

** See Appendix B for templates of all Certifications.

3. Supporting documentation shall consist of the following:

a. Final plat application completed and signed;

b. All documentation necessary to guarantee the complete installation of all required improvements including the Subdivision Improvements Agreement and any documents related to financial security for improvements;

c. An original Title Report or Subdivision Guarantee prepared within the recent 6 months;

d. Evidence that the Montana Department of Environmental Quality or Yellowstone County Public Health Department has approved the sewage disposal system and/or the water system. This applies to individual and public water supply and sewage disposal systems. When applicable and pursuant to Section 23-504, evidence signed by the City shall be submitted;

e. Copies of protective and restrictive covenants, if any;

f. Applicable final plat fee.

(Ord. 07-01 (part), 2007)

APPENDIX K

Subdivision Improvements Agreement

(Name of Subdivision)

- I. Variances (page #):
- II. Conditions that Run with the Land:
- III. Transportation:
 - A. Streets
 - B. Sidewalks
 - C. Street Lighting
 - D. Traffic Control Devices
 - E. Access
 - F. Heritage Trail Plan
 - G. Public Transit
- IV. Emergency Services:
- V. Storm Drainage:
- VI. Utilities:
 - A. Water
 - B. Sanitary Sewer
 - C. Power, Telephone, Gas, and Cable Television
- VII. Parks/Open Space:
- VIII. Irrigation:
- IX. Soils/Geotechnical Study:
- X. Phasing of Improvements:
- XI. Financial Guarantees:
- XII. Legal Provisions:

This agreement is made and entered into this _____ day of _____, 200___, by and between *(Subdivider)*, whose address for the purpose of this agreement is _____, hereinafter referred to as "Subdivider," and the **CITY OF LAUREL or COUNTY OF YELLOWSTONE**, Montana, hereinafter referred to as "City/County."

WITNESSETH:

(for minor subdivisions insert the following)

WHEREAS, the plat of *(Subdivision Name)*, located in the Yellowstone County, Montana, was submitted to the Laurel City-County Planning Board; and

Title 16 - SUBDIVISIONS
APPENDIX K

(for major subdivisions, exclude above and insert the following) WHEREAS, at a regular meeting conducted on _____ day of _____, 200 ____, the City-County Planning Board recommended conditional approval of a preliminary plat of *(Subdivision Name)*; and

(Insert the following for both major and minor subdivisions)

WHEREAS, at a regular meeting conducted on _____ day of _____, 200 ____, the City Council/County Commissioners conditionally approved a preliminary plat of *(Subdivision Name)*; and

WHEREAS, a Subdivision Improvements Agreement is required by the City/County prior to the approval of the final plat.

WHEREAS, the provisions of this agreement shall be effective and applicable to *(Subdivision Name)* upon the filing of the final plat thereof in the Office of the Clerk and Recorder of Yellowstone County, Montana. The Subdivision shall comply with all requirements of the City of Laurel Subdivision Regulations, the rules, regulations, policies, and resolutions of the City of Laurel, Yellowstone County, and the laws and administrative rules of the State of Montana.

THEREFORE, THE PARTIES TO THIS AGREEMENT, for and in consideration of the mutual promises herein contained and for other good and valuable consideration, do hereby agree as follows:

I. VARIANCES

A. Subdivider has requested, and the City/County hereby grants, the following variances from the strict interpretation of these Subdivision Regulations:

1. Variance #1
2. Variance #2

II. CONDITIONS THAT RUN WITH THE LAND*(Insert any applicable conditions in the provided A, B, C format. The following are typical conditions that run with the land, which may or may not be applicable to this subdivision):*

A. Lot owners will be required to construct that segment of the required sidewalk that fronts their property at the time of lot development.

B. Lot owners should be aware that this subdivision is being built in close proximity to prime deer and antelope habitat and it is likely that homeowners will experience problems with damage to landscaped shrubs, flowers, and gardens. The Montana Fish, Wildlife, and Parks Department does not provide damage assistance unless there is damage to commercial crops and/or a threat to public health and safety.

C. Lot owners should be aware that soil characteristics within the area of this subdivision, as described in the 1972 Yellowstone County Soil Survey, indicate that there could be potential limitations for proposed construction on the lots, which may require a geotechnical survey prior to construction.

D. No water rights have been transferred to the lot owners. Irrigation ditches that exist on the perimeter of this development are for the benefit of other properties. Perimeter ditches and drains shall remain in place and shall not be altered by the Subdivider or subsequent owners.

E. There is attached hereto a Waiver waiving the right to protest the creation of the special improvement district or districts, which by this reference is expressly incorporated herein and made as much a part hereof as though fully and completely set forth herein at this point. The Waiver will be filed with the plat, shall run with the land, and shall constitute the guarantee by the Subdivider and property owner or owners of the developments described herein. Said Waiver is effective upon filing and is not conditioned on the completion of the conditions set forth in this Agreement. The Subdivider and owner specifically agree that they are waiving valuable rights and do so voluntarily.

F. Lot owners should be aware that portion(s) of this property lie within the floodplain/floodway, as depicted on the Flood Insurance Rate Maps (FIRM) for this area. Please be advised that special development restrictions may apply within these specified areas.

b;III. TRANSPORTATION

A. Streets

(This section should include, but not be limited to the following):

- Rights-of-way widths
- Pavement widths and surface types
- Curb and gutter design
- Other required street improvements

B. Sidewalks

(This section should include, but not be limited to the following):

- Types of required sidewalk
- Location of required sidewalks
- Widths and surface
- Other required sidewalk improvements

C. Street Lighting*(Describe)*

- Location and types of lighting to be installed, if required

D. Traffic Control Devices *(Describe)*

- Location and type of proposed stop signs and/or signals
- Other required traffic control devices

E. Access*(Describe)*

- Location and widths of proposed accesses
- Restrictions on access
- Other required access improvements

F. Bike or Pedestrian Trail Plans*(Include)*

- Statement of whether subdivision is within Plan
- Location and type of proposed trail or trail connection
- Ownership arrangement of trail corridor-easement or dedication
- Other required trail improvement

G. Public Transit*(Describe)*

- Location and type of improvements required to ensure public transit service

IV. EMERGENCY SERVICE

(This section should include, but not be limited to the following):

- Location and specifications for emergency access road including width, base and surface material, blockade, and required signage
- Urban Wildland Interface Code requirements (required for highly wooded areas)

V. STORM DRAINAGE

All drainage improvements shall comply with the provisions of the *Storm water Management Manual*, and a storm water management plan shall be submitted to and approved by the MDEQ.

(This section should include, but not be limited to the following):

- Description and location of existing and proposed detention facilities
- Any improvements to the existing system
- Other required improvements

VI. UTILITIES

The SIA does not constitute an approval for extension of or connection to water mains and sanitary sewers. The property owner shall make application for extension/connection of water mains and sanitary sewers to the Public Works Department. The extension/connection of/to water mains and sanitary sewers is subject to the approval of the applications and the conditions of approval. Applications shall be submitted for processing prior to the start of any construction and prior to review and approval of any project plans and specifications. The appropriate water and wastewater hookup fees in effect shall be submitted with the applications.

Fees shall be paid for the lots in each phase as applied for in the extension application and as per the first paragraph above. The Developer/Owner acknowledges that the subdivision shall be subject to the applicable System Development Fees in effect at the time new water and/or sanitary sewer service connections are made. The design/installation of sanitary sewers and appurtenances, and water mains and appurtenances (fire hydrants, etc.) shall be in accordance with design standards, specifications, rules, regulations of and as approved by the City of Laurel Public Works Department, Fire Department, and the Montana Department of Environmental Quality.

A. Water

(This section should describe any water facilities unique to the subdivision).

B. Sanitary Sewer

(This section should describe any sanitary sewer facilities unique to the subdivision).

C. Power, Telephone, Gas, and Cable Television

(This section should include, but not be limited to the following):

- Services to be provided within the public right-of-way, existing or to be installed
- Width and location of required utility easements

VII. PARKS/OPEN SPACE

(This section should include, but not be limited to the following):

- The parkland requirement for this subdivision (dedication or cash-in-lieu)
- Required park improvements to the park and timing of construction
- Required formation of a Park Maintenance District

For minor plats, where no parkland dedication is required, please insert the following statement: There is no parkland requirement for proposed (Subdivision Name), as this is a minor subdivision [MCA §76-3-617(3)(a)].

VIII. IRRIGATION

(This section should include, but not be limited to the following):

- Irrigation District affected by the proposed development
- Required mitigation efforts to protect the ditches during construction
- Location and width of existing and proposed onsite easements for ditches

IX. SOILS/GEOTECHNICAL STUDY

(This section should include, but not be limited to the following):

- Results of geotechnical study
- Construction restrictions due to the results of the study
- Required mitigation efforts

X. PHASING OF IMPROVEMENTS(include if applicable)

Description of each Phase including:

- A. Required improvements**
- B. Timing of improvements**
- C. Reference to release of lots (documentation)**
- D. Restrictions on lot sales (documentation)**
- E. Financial guarantees for improvements**

XI. FINANCIAL GUARANTEES

Except as otherwise provided, Subdivider shall install and construct said required improvements with cash or by utilizing the mechanics of a special improvement district or private contracts secured by letters of credit or a letter of commitment to lend funds from a commercial lender. All engineering and legal work in connection with such improvements shall be paid by the contracting parties pursuant to said special improvement district or private contract, and the improvements shall be installed as approved by the Public Works and Public Utilities Department.

XII. LEGAL PROVISIONS

- A.** Subdivider agrees to guarantee all public improvements for a period of one year from the date of final acceptance by the AGB.
- B.** The owners of the properties involved in this proposed Subdivision by signature subscribed herein below agree, consent, and shall be bound by the provisions of this Agreement.
- C.** The covenants, agreements, and all statements in this Agreement apply to and shall be binding on the heirs, personal representatives, successors and assigns of the respective parties.
- D.** In the event it becomes necessary for either party to this Agreement to retain an attorney to enforce any of the terms or conditions of this Agreement or to give any notice required herein, then the prevailing party or the party giving notice shall be entitled to reasonable attorney fees and costs.

Title 16 - SUBDIVISIONS
APPENDIX K

E. Any amendments or modifications of this Agreement or any provisions herein shall be made in writing and executed in the same manner as this original document and shall after execution become a part of this Agreement.

F. Subdivider shall comply with all applicable federal, state, and local statutes, ordinances, and administrative regulations during the performance and discharge of its obligations. Subdivider acknowledges and agrees that nothing contained herein shall relieve or exempt it from such compliance.

IN WITNESS WHEREOF, the parties hereto have set their hands and official seals on the date first above written.

"SUBDIVIDER" (*Name of Subdivider*)

By:

Its:

STATE OF MONTANA

)

: ss

County of Yellowstone

)

On this day of, 200____, before me, a Notary Public in and for the State of Montana, personally appeared, _____, known to me to be the subdivider who executed the foregoing instrument and acknowledged to me that he/she executed the same.

Notary Public in and for the State of Montana

Printed Name: _____

Residing at: _____

My commission expires: _____

This agreement is hereby approved and accepted by the City/County, this ____ day of _____, 200 ____.

"CITY"

CITY OF LAUREL, MONTANA

By: _____

Mayor

Attest: _____

City Clerk

WAIVER OF RIGHT TO PROTEST

FOR VALUABLE CONSIDERATION, the undersigned, being the Subdivider and all of the owners of the hereinafter described real property, do hereby waive the right to protest the formation of one or more special improvement district(s) for street light maintenance and energy, and for the construction of streets, street widening, sidewalks, survey monuments, street name signs, curb and gutter, street lights, driveways, traffic signals, and traffic control devices, parks and park maintenance, trails, sanitary sewer lines, water lines, storm drains (either within or outside the area), and other improvements incident to the above which the City of Laurel or Yellowstone County may require.

Title 16 - SUBDIVISIONS
APPENDIX K

This Waiver and Agreement is independent from all other agreements and is supported by sufficient independent consideration to which the undersigned are parties, and shall run with the land and shall be binding upon the undersigned, their successors and assigns, and the same shall be recorded in the office of the County Clerk and Recorder of Yellowstone County, Montana.

The real property hereinabove mentioned is more particularly described as follows:

Subdivision Description/Name

Signed and dated this _____ day of _____, 200__.

Subdivider/Owner

By: _____

Its: _____

STATE OF MONTANA

)

: ss

County of Yellowstone

)

On this _____ day of _____, 200__, before me, a Notary Public in and for the State of Montana, personally appeared _____, known to me to be *Subdivider/Owner Name*, the person who executed the foregoing instrument and acknowledged to me that he/she executed the same.

IN WITNESS WHEREOF, I have hereunto set my hand and affixed my Notarial Seal the day and year hereinabove written.

Notary Public in and for the State of Montana

Printed name: _____

Residing in Billings, Montana

My commission expires: ;daterrule;

(Ord. 07-01 (part), 2007)

APPENDIX L

Escrow Agreement Template

THIS AGREEMENT is made this _____ day of _____, 200__ by and between _____ ("Purchaser"), whose address for purposes of this Agreement is _____, AMERICAN TITLE & ESCROW, a Montana corporation ("American Title"), of 1216 16th Street West, Alpine Village No. 21, Billings, Montana 59102, the CITY OF LAUREL, MONTANA ("City"), c/o Public Works Director, 115 West First Street, Laurel, Montana 59044, and _____ ("Seller"), whose address for the purposes of this Agreement is _____.

1. Seller has agreed to sell and convey unto Purchaser all of its right, title and interest in and to certain real property in _____ Subdivision, which real property is more particularly described as follows (the "Purchaser's Lot"):

Title 16 - SUBDIVISIONS
APPENDIX L

Lot _____, Block _____, of _____ Subdivision, in the City of Laurel/Yellowstone County, Montana, according to the official plat on file in the office of the Clerk and Recorder of said County, under Document No. _____.

2. In connection with the development of the Subdivision, certain public improvements (the "Improvements") must be made within or adjacent to the Subdivision in accordance with that certain Subdivision Improvements Agreement between Seller and the City dated the ___ day of _____, 200 ___, and recorded the ___ day of _____, 200 ___, under Document No. _____, records of Yellowstone County, Montana (the "SIA"); and

3. Pursuant to Article _____ of the SIA, Seller has agreed that an amount equal to the total estimated cost per square foot of the Improvements multiplied by the total square footage of Purchaser's Lot ("Estimated Costs"), as described in the SIA, with respect to any lot in the Subdivision will be deposited into a separate interest bearing account for the benefit of Purchaser to be held in escrow with American Title; and

4. American Title has agreed to act as escrow agent for the purposes of receiving the above-referenced funds and disbursing the same for payment of future SID assessments upon formation of one or more such districts, or for the payment of one or more private contract costs of constructing the Improvements contemplated by the SIA in the event an SID is not formed, which funds will be obtained, held and disbursed by American Title in accordance with the terms of this agreement.

NOW, THEREFORE, in consideration of the mutual covenants contained herein, the parties do hereby agree as follows:

1. Escrowed Funds. Purchaser shall deposit the Estimated Costs in the amount of _____ (spell out) _____ Dollars (\$_____) (the "escrowed funds") into escrow with American Title in an interest bearing account under Purchaser's Federal Identification Number # _____, for the benefit of Purchaser and the City (the "Escrow Account") at the closing of the sale of the Purchaser's Lot, by Seller to Purchaser. The escrowed funds amount is based upon Estimated Costs of \$_____ per square foot on the _____ square feet of land contained within the Purchaser's Lot. The escrowed funds deposited into the Escrow Account will be held and disbursed by American Title in accordance with the provisions of paragraphs 4, 5 and 6 below.

2. Seller's Obligation Terminated. From and after the date of this Agreement, Seller shall have no further obligation or liability for the Estimated Costs, or the construction and/or payments for the Improvements, or any future SID assessments, relating to the Purchaser's Lot.

3. Purpose of Escrow Arrangement. American Title agrees that it shall receive and hold the escrowed funds in the Escrow Account, for the benefit of Purchaser and the City/County, and shall make disbursements or payments to the AGB and/or Purchaser pursuant to the provisions of paragraphs 4, 5 and 6 below.

4. Payments from Escrow. Upon receipt of a written authorization from Purchaser and the City/County for payments in connection with actual SID assessments or private contracts for construction of the Improvements, American Title shall disburse the escrowed funds as follows:

(a) If one or more special improvement districts are created the escrowed funds shall be paid by American Title to the City for application to the actual assessments for the Improvements against the Purchaser's Lot.

(b) In the event one or more special improvement districts for the Improvements is not or cannot be created, then the amounts held on deposit in the Escrow Account shall be applied toward payment under one or more private contracts for construction of the Improvements attributable to the Purchaser's Lot in accordance with the SIA.

5. Interest on the Escrowed Funds. Interest accrued on the escrowed funds shall be paid to Purchaser in annual disbursements on the first day of December of each year, until such time as final disbursement is made pursuant to paragraph 6 below.

Title 16 - SUBDIVISIONS
APPENDIX L

6. Additional Assessments: Return of Excess. If the actual amount of the special improvement district assessments for the Improvements is greater than the escrowed funds held in the Escrow Account with respect to the Purchaser's Lot; then the City shall levy said difference against the Purchaser's Lot. If the Improvements are constructed by one or more private contracts and the actual amount of the private contracts for the Improvements attributable to the Purchaser's Lot is greater than the escrowed funds held in the Escrow Account with respect to the Purchaser's Lot, then the Purchaser shall be responsible for said difference. If the actual amount of the special improvement district assessments or the private contracts for the Improvements is less than the escrowed funds held in the Escrow Account, then American Title shall return such excess to Purchaser after payment of the full amount of the actual SID assessments or the private contracts, and Purchaser shall be entitled to retain such excess.

7. Escrow Fees. Purchaser and Seller shall share equally the costs associated with initial set-up fees of the Escrow Account, and thereafter Purchaser shall be solely responsible for all other fees, costs, taxes and expenses related to the escrowed funds and the Escrow Account and the performance of duties under this Agreement by American Title. American Title shall have a lien upon all moneys, papers and properties held by it in connection herewith for any fees, costs, or expenses, due American Title hereunder.

8. Scope of Agreement. This Agreement governs only the deposit of the escrowed funds relating to the Purchaser's Lot by Purchaser into escrow with American Title, the disbursement of those funds for payment of actual SID assessments or private contracts, if any, related to the Improvements, to or for the benefit of Purchaser's Lot, and the annual disbursement of interest accrued on the escrowed funds to Purchaser. Other than the matters specifically addressed herein, this Agreement shall not supersede or modify the terms and covenants of the SIA, nor shall any party other than those executing this Agreement be entitled to claim the benefits of this Agreement. No payment made under this Agreement with respect to a private contract for all or any portion of the Improvements shall be evidence of the performance of said private contract, either wholly or in part, and no payment or disbursement by American Title shall be construed to be an acceptance by either Purchaser or the City of defective work or improper materials pursuant to such private contract.

9. Rights and Duties of American Title. It is expressly understood between the parties hereto that American Title is to be considered as a depository and agent to collect, hold and disburse the escrowed funds only, and shall not be responsible or liable in any manner whatsoever for the sufficiency or correctness as to form, manner of execution, or validity of any instructions or authorizations for payment relating to said escrowed funds, nor as to the identity, authority or rights of any person executing such written authorization. American Title assumes no responsibility, nor is it to be held liable, as to the condition of title to the Purchaser's Lot involved herein, nor as to any assessments, liens or encumbrances against the Purchaser's Lot, except with respect to liens or encumbrances arising from the negligence or willful misconduct of American Title with reference to its obligations and duties under this Agreement.

10. Disputes. In the event of any disagreement between the parties hereto or any parties interested herein, resulting in adverse claims and conflicting demands being made in connection with the escrowed funds and the Escrow Account, and disbursements therefrom, American Title shall be entitled at its option to refuse to comply with said conflicting demands so long as such disagreement shall continue. In so refusing, American Title may also refuse to deliver any moneys, papers or property involved in or affected by this escrow, and shall not be or become liable to the parties to this escrow for its failure and/or refusal to comply with the conflicting or adverse demands of the parties hereto. Further, American Title shall be entitled to continue to so refrain to act until (a) the parties hereto have reached an agreement settling their differences and shall have notified American Title in writing of such agreement, or (b) the rights of the parties have been duly adjudicated by a court of competent jurisdiction, except that nothing herein shall be construed to require American Title to institute any litigation to determine the rights of the parties hereto. In the event of any disagreement between the parties hereto, or if conflicting demands or claims are made upon American Title by the parties hereto or interested herein or by any other party, American Title shall have the right to employ legal counsel to advise it and/or represent it in any suit

Title 16 - SUBDIVISIONS
APPENDIX L

or action brought affecting this escrow or the funds held in connection herewith. Purchaser and the City shall be jointly and severally liable to American Title for any and all attorney's fees, costs, and disbursements incurred by American Title in connection herewith, and upon demand shall forthwith pay the same to American Title. The liability of Purchaser and the City for reimbursement for the amount of such attorney's fees, costs and disbursements paid to American Title shall be governed by the provisions of paragraph 12 below.

11. Default: Remedies. The failure of any party to perform its obligations under the terms of this Agreement shall constitute a default hereunder. In the event of any such default, and the failure of the defaulting party to cure the same within ten (10) days after written notice thereof by the non-defaulting party or parties, then such non-defaulting parties may:

- (a) Commence a suit or suits in equity or at law, including without limitation an action for the specific performance of any covenant or agreement contained herein; or
- (b) Commence a suit or suits for damages arising from the failure to perform any covenant or agreement contained herein; or
- (c) Pursue enforcement of any other appropriate legal or equitable remedies.

12. Attorney Fees and Costs. In the event it becomes necessary for any party to this Agreement to retain an attorney to enforce any of the terms or conditions of this Agreement, to give any notice required herein with respect to any default, or to reimburse American Title for any attorney's fees, costs or disbursements it may incur pursuant to paragraph 10 above, then the prevailing party or parties shall be entitled to payment or reimbursement for reasonable attorney's fees, costs and expenses, from the party or parties who do not prevail.

13. Notices. Any notice required under this Agreement shall be served on all other parties either personally or by certified mail, return receipt requested, addressed to the party to be served at the following address:

Purchaser: _____

American Title: 1216 16th Street West

Alpine Village No. 21

Billings, Montana 59102

ATTN: _____

City: c/o Public Works Office

115 North First Street

Laurel, Montana 59044

ATTN: Public Works Director

Seller: _____

A party wishing to change its designated address shall do so by notice in writing to the other party. Notice served by mail shall be deemed complete when deposited in the United States mail, postage prepaid. Rejection or other

Title 16 - SUBDIVISIONS
APPENDIX L

refusal to accept or the inability to deliver because of changed address of which no notice was given shall be deemed to be receipt of the notice.

14. Amendments: Waiver. No amendments or modifications to this Agreement, or of any provisions contained herein, shall be binding or enforceable unless the same shall be in writing and executed in the same manner as this original document and shall after execution become a part of this Agreement. Any waiver or failure to enforce the terms of this Agreement by any of the parties hereto shall not constitute a waiver by said parties of the right to enforce or compel performance with respect to any continuing or subsequent default hereunder.

15. Headings. The headings used herein are for convenience only, and shall not be construed as part of this Agreement or as a limitation on the scope of the particular paragraphs to which they refer.

16. Binding Effect. The covenants, agreements and all statements in this Agreement shall inure to and shall be binding on the heirs, personal representatives, successors and assigns of the respective parties hereto.

IN WITNESS WHEREOF, the parties have executed this Escrow Agreement as of the day and year first above written.

"Purchaser"

By: _____

Its: _____

Federal Tax Identification No. _____

"American Title"

AMERICAN TITLE INSURANCE COMPANY

By: _____

Its: _____

"City"

CITY OF LAUREL, MONTANA

By: _____

Its: _____

"Seller"

By: _____

Its: _____

Federal Tax Identification No. _____

(Ord. 07-01 (part), 2007)

APPENDIX M

Irrevocable Standby Letter of Credit

(Must be on Lender's Letterhead)

DATE

Title 16 - SUBDIVISIONS
APPENDIX M

BENEFICIARY: City of Laurel Public Works, POB 10, Laurel, MT 59044

APPLICANT: Subdivider's name and address

LETTER OF CREDIT NO. _____; EXPIRATION DATE: _____

AT: OUR COUNTERS PRESENTLY LOCATED AT (Lender's address here)

AMOUNT: US\$ _____; NOT EXCEEDING: -US\$ (spell out)

We hereby issue our Irrevocable Standby Letter of Credit available by your draft(s) drawn at sight on us and accompanied by the following documents:

1. Beneficiary's signed statement certifying that _____ (subdivider's name) _____ has failed to pay for required improvements concerning subdividing _____ Subdivision in the City of Laurel, Yellowstone County.
2. Copy of mandatory improvements.
3. The original Letter of Credit

This Letter of Credit shall be deemed extended without amendment for one year from the expiration date, unless thirty days prior to any expiration date we shall notify you by Registered Mail that we elect not to consider this Letter of Credit renewed for any such period. In any communication with us regarding this Letter of Credit, please make specific reference to our Letter of Credit No. at the top of this letter. Drafts drawn under this Credit must bear the clause: "Drawn under _____ Bank Irrevocable Standby Letter of Credit No. _____ dated _____." The amount of each drawing must be endorsed on the reverse of this credit by the negotiating bank. To the extent applicable hereto, this Letter of Credit is subject to the Uniform Customs and Practice for Documentary Credits, 1993 Revision, International Chamber of Commerce Publication, No. 500. We hereby engage with you that draft(s) drawn and/or documents presented and negotiated under and in compliance with the terms of this Irrevocable Standby Letter of Credit will be duly honored upon presentation to us.

_____ BANK

By: _____

(Ord. 07-01 (part), 2007)

APPENDIX N

Restrictions on Transfers and Conveyances Template

_____ SUBDIVISION THIS DECLARATION is made this _____ day of _____ 200____, by (insert owner's name) hereinafter referred to as "Declarant,"

WITNESSETH

WHEREAS, the Declarant is the owner of all of the lots in ;namerrule; Subdivision, situated in Section __, Township _____, Range _____, PMM., City of Laurel, Yellowstone County, Montana, hereinafter referred to as the "Subdivision"; and

WHEREAS, in connection with the filing of the plat for the Subdivision, the Declarant executed that certain Subdivision Improvements Agreement dated the _____ day of ;note, 200____ to the City of Laurel, which Agreement contains restrictions against the sale, conveyance or transfer of certain lots in the Subdivision until such time as a private contract has been executed providing for the installation and construction of required public improvements; and

Title 16 - SUBDIVISIONS
APPENDIX N

WHEREAS, in order to more fully evidence the restriction against sale, conveyance, or transfer and to give third parties notice of such restrictions, the Declarant desires to execute and record this Declaration of Restrictions.

NOW, THEREFORE, in consideration of these premises, the Declarant, for itself and its successors and assigns, does hereby declab0;

1. Except as hereinafter provided, the Declarant does hereby agree and declare that the following described lots shall not be sold, transferred, or conveyed to any third party unless and until a release has been executed and recorded in accordance with the provisions hereinafter appearing:

Phase II:

Lots _____ through _____, inclusive, Block _____; _____ Subdivision in the City of Laurel, according to the official plat on file in the office of the Clerk and Recorder of Yellowstone County, Montana (#_lots total).

Phase III: Lots _____ through _____, inclusive, Block _____; and Lots _____, through _____, inclusive, Block _____, _____ Subdivision in the City of Laurel, according to the official plat on file in the office of the Clerk and Recorder of Yellowstone County, Montana (# lots total).

2. It is the express purpose and intent of this Declaration to restrict or preclude sale, transfer, or conveyance of the above-described lots until such time as a private contract has been executed and necessary funding guarantees provided, as the case may be, providing for the construction and installation of those public improvements required under the above-described Subdivision Improvements Agreement which by reference thereto is hereby incorporated herein as though fully set forth at this point. It is anticipated, however, that the Declarant will develop _____ Subdivision, in distinct phases, upon providing for the installation and construction of the public improvement necessary to serve the particular phase. In that regard a release of some but not all of the above described lots may be executed and recorded from time to time, in accordance with the provisions hereinafter appearing, and upon the recording of said release, the covenants and restrictions contained herein with respect to the lots described in said release shall be deemed canceled and terminated, and of no further force and effect.

3. Upon compliance with the requirements for a private contract specified above, a release for the lot or lots affected thereby shall be executed and recorded by the City of Laurel, pursuant to the provisions contained in the said Subdivision Improvements Agreement. The execution and recording of said release shall be deemed conclusive evidence to all third parties purchasing or acquiring any lot described therein that the restriction against sale, conveyance, or transfer of said lot has been removed.

4. UNTIL SUCH RELEASE IS EXECUTED AND RECORDED, THIS DECLARATION SHALL SERVE AS NOTICE TO ALL THIRD PARTIES PURCHASING OR ACQUIRING ANY OF THE ABOVE-DESCRIBED LOTS OF THE EXPRESS RESTRICTIONS AGAINST ANY SUCH SALE, CONVEYANCE OR TRANSFER, AND OF THE TERMS AND CONDITIONS OF THE SAID SUBDIVISION IMPROVEMENTS AGREEMENT, AND SHALL FURTHER SERVE AS NOTICE THAT THE CITY OF LAUREL MAY ENFORCE ANY AND ALL LEGAL RIGHTS AND REMEDIES SPECIFIED IN THE SUBDIVISION IMPROVEMENTS AGREEMENT SHOULD THE TERMS OF THIS DECLARATION BE VIOLATED.

5. The terms, conditions, and restrictions contained in this Declaration shall not preclude or restrict the ability of the Declarant to (a) sell, convey, and transfer all of the above-described lots, all of the lots in one phase, or those lots remaining subject to the terms of this Declaration, as one unit or group, to a third party, parties or entities; provided, however, that such sale shall be subject to this Declaration and the lots shall continue to be subject to the restrictions herein provided against the sale, transfer and conveyance until a release has been executed and recorded; or (b) enter into sale and purchase agreements for individual lots; provided, however, that the deeds or other conveyance documents shall not be delivered to the prospective buyer nor shall the closing under any such sale and purchase agreements occur until such time as a release covering the affected lot has been executed and recorded.

Title 16 - SUBDIVISIONS
APPENDIX N

6. The terms and conditions of this Declaration shall run with the land and shall be binding upon and shall inure to the benefit of the Declarant, the City of Laurel, and their successors and assigns.

IN WITNESS WHEREOF, the Declarant has executed this Declaration the day and year first above written.

(Name of Declarant)

STATE OF MONTANA
)

: ss.

County of YELLOWSTONE
)

On this _____ day of _____, 20____, before me, a Notary Public in and for the State of Montana, personally appeared _____, known to me to be the person who signed the foregoing instrument and who acknowledged to me that he executed the same.

Notary Public in and for the State of Montana

Printed name: _____

Residing at Billings, Montana

My commission expires: _____

(Ord. 07-01 (part), 2007)

APPENDIX O

Flood Hazard Evaluation

A. Definitions (MCA §76-5-103). Whenever the following words and phrases are used in this Appendix, they shall be given the meaning attributed to them by this section.

1. Channel: The geographical area within either the natural or artificial banks of a watercourse or drainway.
2. Flood: The water of any watercourse or drainway that is above the bank or outside the channel and banks of the watercourse or drainway.
3. Flood of 100-year Frequency (aka Base Flood): A flood having a one percent (1%) chance of being equaled or exceed in any given year. A 100-year flood is the same as a base flood.
4. Floodplain: The area adjoining the watercourse or drainway that would be covered by the floodwater of a flood of 100-year frequency, except for sheetflood areas that receive less than one foot of water per occurrence and are considered "Zone B" by the federal emergency management agency.
5. Floodway: The channel of a stream and the adjacent overbank areas that must be reserved in order to discharge a base flood without cumulatively increasing the water surface elevation more than one half foot.
6. Watercourse: Any depression two feet or more below the surrounding land serving to give direction to a current of water at least nine months of the year and having a bed and well-defined banks.

B. General.

1. Flood Hazard Areas (See MCA §76-3-504): Land subject to being flooded by a flood of 100-year frequency as defined in this Appendix by the Federal Emergency Management Agency (FEMA), or land deemed to be subject to flooding by the City or County, may not be subdivided for building or residential purposes, or other uses that may increase or aggravate flood hazards to the public health, safety or welfare, or that may be prohibited by state or local floodplain or floodway regulations. Land deemed to be subject to flooding by the City or County may include (but is not limited to) land subject to shallow flooding, groundwater rise, historically flooded lands and lands located within 2,000 horizontal feet of the channel bank of the watercourse.

2. Where the 100-year floodway has been delineated by a FEMA Flood Insurance Rate Map (FIRM), a FEMA Floodway Map or a City- or County-approved study on land in a subdivision, the 100-year floodway boundary and 100-year floodplain boundary shall be shown on the plat of the subdivision and the area within the 100-year floodway shall be labeled as a "No-Build Zone."

3. Where the subdivision is within a flood hazard area that has been identified by the City or County, a Flood Study shall be completed as outlined in Part B and Part C of this Appendix, and the 100-year floodway boundary and 100-year floodplain boundary shall be shown on the plat of the subdivision and the area within the 100-year floodway (see Figure 1) shall be labeled as a "No-Build Zone."

C. Flood Study Requirements.

1. A Flood Study shall be required for a subdivision if:

a. Any portion of a proposed subdivision is within 2,000 horizontal feet and less than 20 vertical feet from the channel bank of a watercourse draining an area of 25 square miles or more, and no official floodplain or floodway delineation (study) of the watercourse has been made; or

b. The subdivision is within a flood hazard area that has been identified by the City or County.

2. The Flood Study shall be performed by a registered Professional Engineer experienced in this field of work. Upon the request of the City or County, the study shall be submitted to the Yellowstone County Floodplain Administrator and/or the Floodplain Management Section, Water Resources Division, Montana Department of Natural Resources and Conservation (DNRC) for review and comment. A copy of the Flood Study and written comment from County Floodplain Administrator and/or the DNRC shall be provided to the Planning Department.

D. Flood Study Contents. The Flood Study shall include the following:

1. Certification: Certification by a registered professional engineer, including license number, seal or stamp, signature and date.

2. Written Report: A narrative report containing a description of the study area, data collection, the type of modeling method used for both the hydrology and hydraulics, discussion of the parameters used, modeling results and conclusions.

3. Site Plan: An overall scaled site plan of the subdivision with location of lot lines and an identified scale for vertical and horizontal distance showing the following:

a. Vicinity Map

b. Watercourse

c. 100-year floodplain and floodway boundaries

d. Contours shown at intervals between one (1) foot and four (4) feet depending on the site, or at the discretion of the Floodplain Administrator.

e. Cross-sections

Title 16 - SUBDIVISIONS
APPENDIX O

- f. Bridges or other constrictions in the floodplain
 - g. USGS gauging stations (if any)
 - h. Location and elevation of a temporary benchmark(s) established within the subdivision and referenced to mean sea level with appropriate elevation adjustment.
4. Cross-sectional information:
- a. Cross-section elevations and stations should be determined at points representing significant breaks in ground slope and at changes in the hydraulic characteristics of the floodplain (i.e., points where ground cover, soil, or rock conditions change). Elevations shall be reported in NAVD 88 or NGVD 29 datum.
 - b. The number of cross-sections needed, and the distance between cross-sections will vary depending on the site, the slope of the watercourse, the slope of the channel, and the hydraulic characteristics of the reach. A minimum of four cross sections are required over the entire reach with at least two cross-sections at the property where the elevations are desired. Additional cross-sections shall be taken above, below and at bridges, control structures, or natural constrictions in topography.
 - c. Each cross-section shall cross the entire floodplain. The cross-section alignment should be perpendicular to the general flow of the watercourse (approximately perpendicular to contour lines). Elevation stations should be recorded at the channel bank and within the channel to determine the channel bottom shape. Cross sections shall be reasonably spaced to accurately define the study area.
 - d. A profile sheet scaled the same as a FEMA Flood Insurance Study showing the observed water surface profile, base flood elevation, location of cross sections, subdivision boundaries, watercourse profile, and thalweg (lowest point of the channel bottom along the reach of the watercourse).
5. Bridges/Culverts/Pipes: Provide descriptions and sketches of all bridges, culverts and pipes within the reach, showing unobstructed waterway openings and elevations.
6. Water Surface: Base Flood elevation of the water surface is to be determined and shown on each valley cross section.
7. Supporting Documentation: Provide engineering reports of calculations and assumptions, historical references, research of published hydrology or calculations showing how hydrology was derived, and other documentation of research information.
8. Electronic Data: Provide maps and any other information provided for a Flood Study that may be utilized by FEMA that meets their specific guidelines for digital and electronic data. Please refer to FEMA's Flood Hazard Mapping Program at www.fema.gov/fhm/ for specific guidelines and specifications for data collection.

Figure 1. 100-Year Floodplain Cross-Section Diagram*

* Please contact the Yellowstone County floodplain administrator at (406) 628-4796 for further information.
(Ord. 07-01 (part), 2007)

APPENDIX P

Fee Schedule*

* Please see the City of Laurel's Official Schedule of Fees and Charges available in the Clerk's office and/or the Public Works Department.

(Ord. 07-01 (part), 2007)

Title 16 - SUBDIVISIONS
APPENDIX P
